

5-3-2016

# Modules Over Rank 2 KLR Algebras

Jonathan Brian Judge

*University of Connecticut - Storrs*, [jonathan.judge@uconn.edu](mailto:jonathan.judge@uconn.edu)

Follow this and additional works at: <https://opencommons.uconn.edu/dissertations>

---

## Recommended Citation

Judge, Jonathan Brian, "Modules Over Rank 2 KLR Algebras" (2016). *Doctoral Dissertations*. 1089.  
<https://opencommons.uconn.edu/dissertations/1089>

# Modules Over Rank 2 KLR Algebras

Jonathan Brian Judge

University of Connecticut, 2016

## ABSTRACT

The module categories of Khovanov-Lauda-Rouquier algebras categorify the integral form of the negative half of the quantum group  $\mathbf{U}_q(\mathfrak{g})$  coming from any symmetrizable Kac-Moody algebra  $\mathfrak{g}$ . We construct a family of simple modules over KLR algebras and show how they can be used to obtain the building blocks of existing classifications of simple finite-dimensional modules in finite types. The construction extends to infinite types, where we obtain simple modules whose structures are easy to describe. We give many explicit examples of this construction in rank 2 cases.

# Modules Over Rank 2 KLR Algebras

Jonathan Brian Judge

M.S. Mathematics, University of Connecticut, 2011

B.A. Mathematics, Boston University, 2007

A Dissertation

Submitted in Partial Fulfillment of the

Requirements for the Degree of

Doctor of Philosophy

at the

University of Connecticut

2016

Copyright by

Jonathan Brian Judge

2016

# APPROVAL PAGE

Doctor of Philosophy Dissertation

## Modules Over Rank 2 KLR Algebras

Presented by

Jonathan Brian Judge, B.A. Math., M.S. Math.

Major Advisor

---

Kyu-Hwan Lee

Associate Advisor

---

Ralf Schiffler

Associate Advisor

---

Jerzy Weyman

University of Connecticut

2016

## ACKNOWLEDGMENTS

First and foremost I thank my advisor, Kyu-Hwan Lee. Without his insight, wisdom, guidance, patience and encouragement over the last few years, I could not possibly have completed this work.

I also thank my committee members, Ralf Schiffler and Jerzy Weyman. They are excellent mathematicians who have taught me many lessons about representation theory and about mathematical research, both inside and outside their courses.

There are many in the Mathematics Department at UConn to whom I owe thanks. Amit Savkar is a passionate mathematical educator and he has given me many work opportunities. Keith Conrad's lectures and notes are gems of mathematical exposition that have markedly improved my teaching and writing. Many others have contributed significantly to my development, including Masha Gordina, David Gross, Álvaro Lozano-Robledo, Tom Roby, and Monique Roy.

My classmates and officemates Michael Mackenzie, David Miller, and Sandi Xhumari have been great friends and sources of much comic relief. My academic brothers Jon Axtell, Gabe Feinberg, Phil Lombardo, and Ben Salisbury have been a source of inspiration.

Lastly, I thank my parents, Brian and Celeste. Without their steady support over the years, I could not have made it this far.

# Contents

- Ch. 1. Introduction** 1

  - 1.1 Background and motivation 1
  - 1.2 Results 3

- Ch. 2. Preliminaries** 4

  - 2.1 Cartan datum 4
  - 2.2 Combinatorial conventions 6
  - 2.3 Quantum groups 8
  - 2.4 Crystal bases 9
  - 2.5 Canonical bases 12

- Ch. 3. Categorification of Quantum Groups** 14

  - 3.1 The definition of KLR algebras 14
  - 3.2 Modules over KLR algebras 19
  - 3.3 Induction and restriction 21
  - 3.4 Grothendieck groups and categorification 23
  - 3.5 Graded dimensions and characters 24

- Ch. 4. Finite-dimensional Modules Over KLR algebras** 27

  - 4.1 Simple  $R(m\alpha_i)$ -modules 27
  - 4.2 Crystal structure on modules 28
  - 4.3 Standard module theory 36

- Ch. 5. Simple Monoweight Modules** 41

  - 5.1 Construction and first properties 41
  - 5.2 Monoweight  $i$ -jump modules 47

5.3	Building blocks of crystal theory . . . . .	52
5.4	Building blocks of standard module theory . . . . .	54
<b>Ch. 6.</b>	<b>Modules Over Rank 2 KLR Algebras</b>	<b>57</b>
6.1	Finite type . . . . .	58
6.1.1	Type $A_2$ . . . . .	58
6.1.2	Type $B_2$ . . . . .	58
6.1.3	Type $G_2$ . . . . .	59
6.2	Affine type . . . . .	60
6.2.1	Type $A_1^{(1)}$ . . . . .	60
6.2.2	Type $A_1^{(2)}$ . . . . .	61
6.3	Hyperbolic type . . . . .	62
	<b>Appendices</b>	<b>63</b>
<b>Ch. A.</b>	<b>Reference Tables</b>	<b>64</b>
A.1	Dynkin diagrams . . . . .	64
A.2	Positive roots . . . . .	64
<b>Ch. B.</b>	<b>Basis Reduction</b>	<b>67</b>
B.1	Reducing to a sum over a chosen basis . . . . .	67
	<b>Bibliography</b>	<b>69</b>



# Chapter 1

## Introduction

### 1.1 Background and motivation

The Drinfeld-Jimbo quantum groups are Hopf algebras defined as deformations of the universal enveloping algebras of symmetrizable Kac-Moody algebras (see Section 2.3). They arose in the 1980s from studies in mathematical physics. Since their discovery, they have been a focus of research by both physicists and mathematicians.

Kashiwara and Lusztig identified the crystal and canonical (or global crystal) bases of quantum groups [Kas91, Lus90]. These bases have remarkable properties that have contributed much to our understanding of quantum groups and their representations. We give a brief exposition of them in Sections 2.4 and 2.5. They have also led to the development of interesting combinatorics. For example, the search for combinatorial realizations of crystal bases led to generalizations of the Littlewood-Richardson rule.

Khovanov and Lauda [KL09, KL11] and Rouquier [Rou08] independently achieved a categorification of quantum groups. More precisely, they showed that by taking direct sums

of Grothendieck groups of module categories over certain families of  $\mathbb{Z}$ -graded algebras, one obtains bialgebra structures isomorphic to (halves of) integral forms of quantum groups. We review this categorification in Chapter 3. The algebras they introduced are now appropriately called KLR (or quiver Hecke) algebras, and the simple modules over such algebras correspond to certain bases of quantum groups. We discuss these modules in Chapter 4.

There are two main approaches to classifying the finite-dimensional simple modules over KLR algebras: a crystal theory and a standard module theory. We review these in Sections 4.2 and 4.3. The crystal theory is due to Lauda and Vazirani [LV11], while the standard module theory was first developed by Kleshchev and Ram [KR11], then Hill, Melvin, and Mondragon [HMM12], and also McNamara [McN15].

A key benefit of the crystal classification is its generality: it applies in all symmetrizable Cartan types. One drawback, however, is that the description of the simple modules usually is not explicit. Benkart, Kang, Oh, and Park showed that more could be said in finite Cartan types [BKOP14]. Specifically, they showed that there is a family of simple 1- and 2-dimensional building blocks which can be used to construct all the finite-dimensional simple modules, and the corresponding construction is parameterized by Littelmann’s adapted strings [Lit98].

The classification of finite-dimensional simple modules using the standard module theory also yields some explicit information about simple modules. In particular the building blocks of this theory are *cuspidal* modules – one for each positive root – and they have been constructed explicitly in most cases. Outside of finite and certain affine types [Kle14, McN14], little is understood explicitly.

## 1.2 Results

A main theme of this work is describing the simple modules over KLR algebras as explicitly as possible. Usually this means that we want a straightforward parameterization of simple modules, as well as knowledge of their graded characters. See Section 3.5 for information on graded characters.

Our main results are in Chapter 5. We have identified a class of simple modules, which we call *simple monoweight modules*. If a word  $\mathbf{i}$ , whose letters are in an indexing set  $I$ , satisfies certain conditions easily determined by entries in the Cartan matrix, we can construct a simple module  $L(\mathbf{i})$  whose graded character is concentrated entirely in weight  $\mathbf{i}$ . See Theorem 5.1.1 and its corollary for precise details. This provides a uniform construction for most of the building blocks of existing classifications of simple modules in finite Cartan types. See Sections 5.3 and 5.4 for details.

Of particular importance to the crystal theory of KLR algebra modules is what Lauda and Vazirani call the “Jump Lemma” (see Lemma 4.2.2). We have determined conditions which guarantee exactly when a simple monoweight module satisfies the equivalent conditions of the Jump Lemma (see Proposition 5.2.3). This leads immediately to the construction of more simple modules whose graded characters can be computed explicitly.

In Chapter 6 we apply our results to compute many examples of simple modules in rank 2 cases. This includes computations in hyperbolic types, where little was known explicitly prior to this work.

# Chapter 2

## Preliminaries

The purpose of this chapter is to establish notational conventions which will be used freely throughout this dissertation. The content on quantum groups and crystal bases may be found in standard references such as [HK02] and [Lus10].

### 2.1 Cartan datum

Let  $I$  be a finite set. A matrix  $A = (a_{ij})_{i,j \in I}$  is called a *symmetrizable generalized Cartan matrix* if it satisfies the following conditions for all  $i, j \in I$ :

- (1)  $a_{ii} = 2$ ,
- (2)  $a_{ij} \in \mathbb{Z}_{\leq 0}$  for  $i \neq j$ ,
- (3)  $a_{ij} = 0$  if and only if  $a_{ji} = 0$ ,
- (4) there is a diagonal matrix  $D = \text{diag}(d_i \in \mathbb{Z}_{>0} \mid i \in I)$  such that  $DA$  is symmetric.

Now suppose that

- $A$  is a symmetrizable generalized Cartan matrix,
- $P$  is a free abelian group of finite rank (the *weight lattice*),
- $\Pi = \{\alpha_i \mid i \in I\}$  (the *simple roots*),
- $P^\vee = \text{Hom}_{\mathbb{Z}}(P, \mathbb{Z})$  (the *dual weight lattice*),
- $\Pi^\vee = \{h_i \mid i \in I\}$  (the *simple coroots*),
- $\mathfrak{h} = \mathbb{C} \otimes_{\mathbb{Z}} P^\vee$ ,
- $\Pi \subset \mathfrak{h}^*$  and  $\Pi^\vee \subset \mathfrak{h}$  are linearly independent with  $\alpha_j(h_i) = a_{ij}$  for  $i, j \in I$ .

Then we call the tuple  $(A, P, \Pi, P^\vee, \Pi^\vee)$  a *Cartan datum*. We have the pairing  $\langle \cdot, \cdot \rangle : P^\vee \times P \rightarrow \mathbb{Z}$  given by  $\langle h_i, \alpha_j \rangle := a_{ij}$ , and we define a symmetric bilinear form on  $\mathfrak{h}^*$  satisfying  $(\alpha_i, \alpha_j) = d_i a_{ij}$  for  $i, j \in I$ . We also define:

- the *fundamental weights*

$$\{\Lambda_i \in P \mid \langle h_j, \Lambda_i \rangle = \delta_{ij} \text{ for } i, j \in I\},$$

- the *root lattice*

$$Q = \bigoplus_{i \in I} \mathbb{Z} \alpha_i, \text{ and}$$

- the *positive root lattice*

$$Q^+ = \bigoplus_{i \in I} \mathbb{Z}_{\geq 0} \alpha_i.$$

For an element  $\alpha = \sum k_i \alpha_i$  in the positive root lattice  $Q^+$ , we define its *height* to be  $\text{ht}(\alpha) = \sum k_i$ .

From every Cartan datum one may construct a symmetrizable Kac-Moody algebra, typically denoted  $\mathfrak{g}$  (see [Kac90]). Generalized Cartan matrices can be broadly classified as follows.

**Definition 2.1.1.** An indecomposable generalized Cartan matrix  $A$  is said to have:

- *finite type* if all its principal minors are positive.
- *affine type* if  $\det A = 0$  and all its proper principal minors are positive.
- *indefinite type* if it is neither finite nor affine.

It is well known that finite type generalized Cartan matrices classify simple finite-dimensional (complex) Lie algebras. In fact, the Kac-Moody algebra constructed from a finite type generalized Cartan matrix coincides with the corresponding Lie algebra. One may draw a Dynkin diagram encoding the information contained in a Cartan matrix; see Table A.1.1 for a complete list of Dynkin diagrams in finite type.

## 2.2 Combinatorial conventions

We shall refer to finite sequences of elements of  $I$  as *words*. We denote the set of such words by  $\langle I \rangle$ , and we make the following definitions for  $\mathbf{i} = i_1 i_2 \dots i_m \in \langle I \rangle$ :

$$\ell(\mathbf{i}) := m, \tag{2.2.1}$$

$$|\mathbf{i}| := \alpha_{i_1} + \alpha_{i_2} + \dots + \alpha_{i_m} \in Q^+. \tag{2.2.2}$$

For fixed  $\alpha \in Q^+$ , we set

$$I^\alpha = \{\mathbf{i} \in \langle I \rangle \mid |\mathbf{i}| = \alpha\}.$$

If  $\alpha$  has height  $m$ , then the symmetric group  $S_m$  acts on words in  $I^\alpha$  by permuting places.

We let  $s_r$  denote the simple transposition  $(r, r + 1) \in S_m$  so that

$$s_r(i_1 \dots i_{r-1} i_r i_{r+1} i_{r+2} \dots i_k) = i_1 \dots i_{r-1} i_{r+1} i_r i_{r+2} \dots i_k.$$

For  $\mathbf{i} \in I^\alpha$  and  $\mathbf{j} \in I^\beta$ , we denote their concatenation by  $\mathbf{ij} \in I^{\alpha+\beta}$ . A *shuffle*  $\mathbf{k}$  of words  $\mathbf{i}$  and  $\mathbf{j}$  is a word in which  $\mathbf{i}$  and  $\mathbf{j}$  are complementary subwords. We shall denote the set of shuffles of  $\mathbf{i}$  and  $\mathbf{j}$  by  $\text{Sh}(\mathbf{i}, \mathbf{j})$ . This set is in bijection with  $S_{\ell(\mathbf{ij})}/S_{\ell(\mathbf{i})} \times S_{\ell(\mathbf{j})}$ .

**Example 2.2.1.** Let  $\mathbf{i} = 121$ ,  $\mathbf{j} = 122121$  and  $\mathbf{k} = 112221121$ . One shuffle of  $\mathbf{i}$  and  $\mathbf{j}$  that produces  $\mathbf{k}$  is represented diagrammatically as follows:

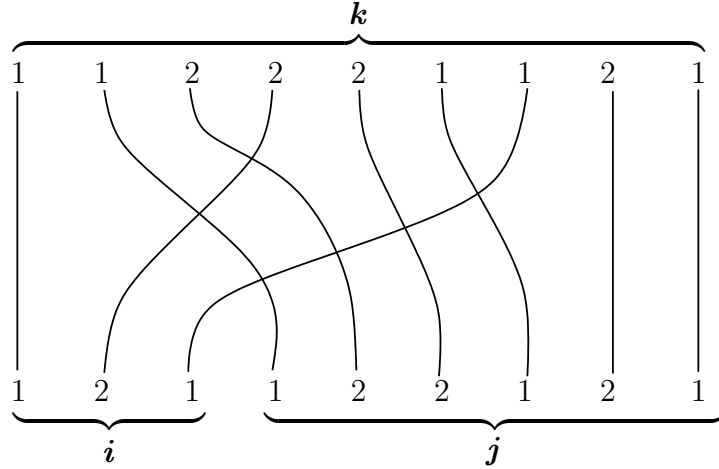

Note that this is not the only shuffle of  $\mathbf{i}$  and  $\mathbf{j}$  that produces the word  $\mathbf{k}$ . We shall revisit this diagram in Section 3.5, where it will have a new interpretation in module-theoretic terms.

It frequently will be necessary for us to fix a set of minimal-length representatives of

elements in a symmetric group  $S_m$ ; we denote such a choice of representatives by  $[S_m]$ . If  $P = (m_1, \dots, m_k)$  is a composition of  $m$ , so  $m = m_1 + \dots + m_k$ , we let  $S_P = S_{m_1} \times \dots \times S_{m_k}$  denote the corresponding parabolic subgroup of  $S_m$ , and we let  $[S_m/S_P]$  denote a choice of minimal-length representatives of the cosets  $S_m/S_P$ . For an element  $w$  in  $S_m$  or  $S_m/S_P$ , we write  $\widehat{w}$  for the corresponding choice of minimal-length representative in  $[S_m]$  or  $[S_m/S_P]$ .

Let  $q$  be an indeterminate. For  $i \in I$  and nonnegative integers  $m, n$ , we define

$$q_i = q^{d_i}, \quad [n]_i = \frac{q_i^n - q_i^{-n}}{q_i - q_i^{-1}}, \quad [n]_i! = \prod_{k=1}^n [k]_i, \quad \begin{bmatrix} m \\ n \end{bmatrix}_i = \frac{[m]_i!}{[n]_i! [m-n]_i!}.$$

Suppose we have a function  $h_{i,j} : \text{Sh}(\mathbf{i}, \mathbf{j}) \rightarrow \mathbb{Z}$  for any two words  $\mathbf{i}, \mathbf{j} \in \langle I \rangle$ . Suppose also that  $f$  and  $g$  are functions on  $I^\alpha$  and  $I^\beta$ , respectively. If they take values in a ring which contains  $\mathbb{Z}[q, q^{-1}]$  in its center, we define their *quantum shuffle product* (with respect to  $h_{i,j}$ ) as the function  $f \omega g$  on  $I^{\alpha+\beta}$  given by

$$(f \omega g)(\mathbf{k}) = \sum_{\mathbf{k} \in \text{Sh}(\mathbf{i}, \mathbf{j})} q^{h_{i,j}(\mathbf{k})} f(\mathbf{i})g(\mathbf{j}). \quad (2.2.3)$$

This is inspired by work of Leclerc [Lec04]. Later we study the case in which  $f$  and  $g$  are graded characters of certain  $\mathbb{Z}$ -graded modules which take values in the free  $\mathbb{Z}[q, q^{-1}]$ -module generated by  $\langle I \rangle$ .

## 2.3 Quantum groups

**Definition 2.3.1.** The *quantum group*  $U_q(\mathfrak{g})$  associated to the Cartan datum

$(A, P, \Pi, P^\vee, \Pi^\vee)$  is the unital associative algebra over  $\mathbb{Q}(q)$  generated by  $e_i, f_i$  ( $i \in I$ ) and



$q^h$  ( $h \in P^\vee$ ) subject to the following relations:

$$(1) \quad q^0 = 1, \quad q^h q^{h'} = q^{h+h'} \text{ for } h, h' \in P^\vee,$$

$$(2) \quad q^h e_i q^{-h} = q^{\langle h_i, \alpha_i \rangle} e_i, \quad q^h f_i q^{-h} = q^{-\langle h_i, \alpha_i \rangle} f_i \text{ for } h \in P^\vee \text{ and } i \in I,$$

$$(3) \quad e_i f_j - f_j e_i = \delta_{ij} \frac{K_i - K_i^{-1}}{q_i - q_i^{-1}}, \text{ where } K_i = q^{d_i h_i},$$

$$(4) \quad \sum_{k=0}^{1-a_{ij}} (-1)^k \begin{bmatrix} 1-a_{ij} \\ k \end{bmatrix}_i e_i^{1-a_{ij}-k} e_j e_i^k = 0 \text{ if } i \neq j,$$

$$(5) \quad \sum_{k=0}^{1-a_{ij}} (-1)^k \begin{bmatrix} 1-a_{ij} \\ k \end{bmatrix}_i f_i^{1-a_{ij}-k} f_j f_i^k = 0 \text{ if } i \neq j.$$

Relations (4) and (5) are called the (*quantum*) *Serre relations*. There is an important antiautomorphism  $\bar{\cdot} : \mathbf{U}_q(\mathfrak{g}) \rightarrow \mathbf{U}_q(\mathfrak{g})$  which fixes  $e_i$  and  $f_i$  for all  $i \in I$ , but sends  $q$  to  $q^{-1}$  and  $q^h$  to  $q^{-h}$ . One can show that  $\mathbf{U}_q(\mathfrak{g})$  is, in fact, a Hopf algebra (see [HK02]), but details of the comultiplication and antipode are not needed in this dissertation.

Let  $\mathbf{U}_q^-(\mathfrak{g})$  be the subalgebra of  $\mathbf{U}_q(\mathfrak{g})$  generated by  $f_i$  ( $i \in I$ ). Let  $\mathcal{A} = \mathbb{Z}[q, q^{-1}]$ . Of particular importance to us is the  $\mathcal{A}$ -form of  $\mathbf{U}_q^-(\mathfrak{g})$ , which we denote by  ${}_{\mathcal{A}}\mathbf{U}_q^-(\mathfrak{g})$ . It is the  $\mathcal{A}$ -subalgebra of  $\mathbf{U}_q^-(\mathfrak{g})$  generated by the divided powers

$$f_i^{(n)} := \frac{f_i^n}{[n]_i!} \quad (i \in I, n \in \mathbb{N}).$$

## 2.4 Crystal bases

Crystal bases were first developed by Kashiwara [Kas91], and they have since become ubiquitous tools in the study of quantum groups and their representations. The key properties

of crystal bases have been distilled into the combinatorial notion of an abstract crystal.

**Definition 2.4.1.** An *abstract crystal* is a set  $B$  together with maps  $\text{wt} : B \rightarrow P$ ,  $\varphi_i, \varepsilon_i : B \rightarrow \mathbb{Z} \cup \{-\infty\}$  and  $\tilde{e}_i, \tilde{f}_i : B \rightarrow B \cup \{0\}$  ( $i \in I$ ) satisfying the following conditions:

- (1)  $\varphi_i(b) = \varepsilon_i(b) + \langle h_i, \text{wt}(b) \rangle$ ,
- (2)  $\text{wt}(\tilde{e}_i b) = \text{wt}(b) + \alpha_i$ ,  $\text{wt}(\tilde{f}_i b) = \text{wt}(b) - \alpha_i$  if  $\tilde{e}_i b, \tilde{f}_i b \in B$ ,
- (3) for  $b, b' \in B$  and  $i \in I$ ,  $b' = \tilde{e}_i b$  if and only if  $b = \tilde{f}_i b'$ ,
- (4) for  $b \in B$ , if  $\varphi_i(b) = -\infty$ , then  $\tilde{e}_i b = \tilde{f}_i b = 0$ ,
- (5) if  $b \in B$  and  $\tilde{e}_i b \in B$ , then  $\varepsilon_i(\tilde{e}_i b) = \varepsilon_i(b) - 1$ ,  $\varphi_i(\tilde{e}_i b) = \varphi_i(b) + 1$ ,
- (6) if  $b \in B$  and  $\tilde{f}_i b \in B$ , then  $\varepsilon_i(\tilde{f}_i b) = \varepsilon_i(b) + 1$ ,  $\varphi_i(\tilde{f}_i b) = \varphi_i(b) - 1$ .

Property (3) allows for a graphical interpretation of crystals, and one often considers the *crystal graph*. In particular, if  $b' = \tilde{f}_i b$ , then the crystal graph contains nodes for  $b$  and  $b'$ , and an arrow from  $b$  to  $b'$  that is colored by  $i$ . One can think of the maps  $\varepsilon_i$  and  $\varphi_i$  as encoding the position of a node  $b$  with respect to the operators  $\tilde{e}_i$  and  $\tilde{f}_i$  on an  $i$ -string of the crystal graph.

We finish this section with Kashiwara's description of the crystal basis  $B(\infty)$  of  $\mathbf{U}_q^-(\mathfrak{g})$  as in [Kas91]. Consider the quantum divided powers

$$e_i^{(k)} = \frac{e_i^k}{[k]_i!} \quad \text{and} \quad f_i^{(k)} = \frac{f_i^k}{[k]_i!}.$$

For each  $u \in \mathbf{U}_q^-(\mathfrak{g})$ , there exist unique  $u', u'' \in \mathbf{U}_q^-(\mathfrak{g})$  such that

$$e_i u - u e_i = \frac{K_i u' - K_i^{-1} u''}{q_i - q_i^{-1}}.$$

This allows us to define an endomorphism  $e'_i$  on  $\mathbf{U}_q^-(\mathfrak{g})$  by  $e'_i(u) = u'$ .

For each  $i \in I$ , every element  $u \in \mathbf{U}_q^-(\mathfrak{g})$  has an  $i$ -decomposition

$$u = \sum_{k \geq 0} f_i^{(k)} u_k$$

in which  $u_k \in \ker e'_i$  for each  $k$ . The *Kashiwara operators*  $\tilde{e}_i$  and  $\tilde{f}_i$  are endomorphisms on  $\mathbf{U}_q^-(\mathfrak{g})$  defined, respectively, by

$$\tilde{e}_i u = \sum_{k \geq 1} f_i^{(k-1)} u_k \quad \text{and} \quad \tilde{f}_i u = \sum_{k \geq 0} f_i^{(k+1)} u_k.$$

Let  $Q_0$  be the subring of functions in  $\mathbb{Q}(q)$  that are regular at  $q = 0$ . For  $\mathbf{i} = i_1 i_2 \dots i_k \in \langle I \rangle$ , we set  $\tilde{f}_{\mathbf{i}} = \tilde{f}_{i_1} \dots \tilde{f}_{i_k}$ . Let  $L(\infty)$  be the  $Q_0$ -lattice spanned by

$$\mathcal{B} = \{\tilde{f}_{\mathbf{i}} 1 \in \mathbf{U}_q^-(\mathfrak{g}) \mid \mathbf{i} \in \langle I \rangle\}.$$

We define  $B(\infty)$  to be the image of  $\mathcal{B}$  under the natural projection  $L(\infty) \rightarrow L(\infty)/qL(\infty)$ . In fact,  $B(\infty)$  is a  $\mathbb{Q}$ -basis of  $L(\infty)/qL(\infty)$ . The Kashiwara operators  $\tilde{e}_i$  and  $\tilde{f}_i$  act on  $L(\infty)/qL(\infty)$  and they satisfy

$$\tilde{e}_i B(\infty) \subset B(\infty) \cup \{0\}, \quad \text{and} \quad \tilde{f}_i B(\infty) \subset B(\infty).$$

Define  $\text{wt} : B(\infty) \rightarrow \mathbb{Z} \cup \{\infty\}$  by  $\text{wt}(\tilde{f}_{\mathbf{i}} 1) = |\mathbf{i}| \in \mathbb{Q}^+$  for all  $\mathbf{i} \in \langle I \rangle$ . For  $b \in B(\infty)$  and  $i \in I$ , put

$$\varepsilon_i(b) = \max\{k \geq 0 \mid \tilde{e}_i^k b \neq 0\} \quad \text{and} \quad \varphi_i(b) = \varepsilon_i(b) + \langle h_i, \text{wt}(b) \rangle.$$

The maps  $\text{wt}$ ,  $\varepsilon_i$ ,  $\varphi_i$ ,  $\tilde{e}_i$  and  $\tilde{f}_i$  taken over  $i \in I$  make  $B(\infty)$  into an abstract crystal.

We can also describe a basis of  $\mathbf{U}_q^-(\mathfrak{g})$  in terms of  $B(\infty)$ . For  $b \in B(\infty)$ , there is a unique element  $g(b) \in L(\infty) \cap \overline{L(\infty)}$  such that  $b$  is the image of  $g(b)$  under the natural projection  $L(\infty) \rightarrow L(\infty)/qL(\infty)$ . The set

$$G(\infty) = \{g(b) \mid b \in B(\infty)\}$$

forms a basis of  $\mathbf{U}_q^-(\mathfrak{g})$  called the *(lower) global crystal basis*.

**Remark 2.4.2.** While we need only the  $B(\infty)$  crystal in this dissertation, the reader should be aware that there is a well-developed theory of crystals for highest weight modules. See [\[HK02\]](#) for an introduction.

## 2.5 Canonical bases

The canonical basis for a quantum group was originally defined by Lusztig in [\[Lus90\]](#). Suppose that  $\mathfrak{g}$  is a Lie algebra coming from a finite type Cartan matrix. Let  $W$  denote the associated Weyl group, which is generated by simple reflections  $s_i$  ( $i \in I$ ). Let  $w_0$  be the longest element of  $W$ . If  $N$  is the number of positive roots of  $\mathfrak{g}$ , then every minimal-length representation of  $w_0$  is of the form  $s_{i_1}s_{i_2}\dots s_{i_N}$ , and we call  $(i_1, i_2, \dots, i_N)$  the sequence of  $w_0$ .

Fix a choice of reduced expression for  $w_0$  and let  $\mathbf{i} = (i_1, \dots, i_N)$  be its sequence. For each  $\mathbf{c} = (c_1, \dots, c_N) \in \mathbb{Z}_{\geq 0}^N$ , we set

$$f_{\mathbf{i}}^{\mathbf{c}} = f_{i_1}^{(c_1)} T_{i_1, -1}''(f_{i_2}^{(c_2)}) \dots T_{i_1, -1}'' T_{i_2, -1}'' \dots T_{i_{N-1}, -1}''(f_{i_N}^{(c_N)}),$$

where  $T_{i, -1}''$  ( $i \in I$ ) denote Lusztig's automorphisms as in [\[Lus10, Chapter 6\]](#). The set

$B_i := \{f_i^{\mathbf{c}} \mid \mathbf{c} \in \mathbb{Z}_{\geq 0}^N\}$  is a  $\mathbb{Q}(q)$ -basis of  $\mathbf{U}_q^-(\mathfrak{g})$ . We call it the *PBW basis* of  $\mathbf{U}_q^-(\mathfrak{g})$ . Remarkably, the  $\mathbb{Z}[q]$ -span of  $B_i$  is independent of the choice of reduced expression of  $w_0$ ; denote it by  $\mathcal{L}$ .

Now let  $\pi : \mathcal{L} \rightarrow \mathcal{L}/q\mathcal{L}$  be the natural projection. Then  $\pi(B_i)$  is a  $\mathbb{Z}$ -basis of  $\mathcal{L}/q\mathcal{L}$  independent of the choice of reduced expression for  $w_0$ . Restricting to  $\mathcal{L} \cap \bar{\mathcal{L}}$ , we obtain a  $\mathbb{Z}$ -module isomorphism:

$$\bar{\pi} : \mathcal{L} \cap \bar{\mathcal{L}} \rightarrow \mathcal{L}/q\mathcal{L}.$$

Set  $\mathbf{B} = \bar{\pi}^{-1}(\pi(B_i))$ . Then  $\mathbf{B}$  is a  $\mathbb{Q}(q)$ -basis of  $\mathbf{U}_q^-(\mathfrak{g})$  which we call the *canonical basis*. Grojnowski and Lusztig showed that the lower global basis  $\mathcal{G}(\infty)$  and the canonical basis  $\mathbf{B}$  coincide [[GL93](#)].

# Chapter 3

## Categorification of Quantum Groups

In this chapter we review the categorification of the integral form of the negative half  $\mathbf{U}_q^-(\mathfrak{g})$  of the quantum group  $\mathbf{U}_q(\mathfrak{g})$ . This was first described in the works of Khovanov and Lauda [KL09, KL11], and Rouquier [Rou08].

### 3.1 The definition of KLR algebras

Let  $\mathbb{k}$  be an algebraically closed field and let  $\alpha \in Q^+$  with  $\text{ht}(\alpha) = m$ .

**Definition 3.1.1.** The *KLR (or quiver Hecke) algebra*  $R(\alpha)$  is the associative  $\mathbb{Z}$ -graded unital  $\mathbb{k}$ -algebra with generators

$$\{e(\mathbf{i}) \mid \mathbf{i} \in I^\alpha\} \cup \{y_r \mid 1 \leq r \leq m\} \cup \{\tau_r \mid 1 \leq r \leq m-1\}$$

subject to the following relations for  $\mathbf{i}, \mathbf{j} \in I^\alpha$ :

$$\sum_{\mathbf{i} \in I^\alpha} e(\mathbf{i}) = 1, \quad (3.1.1)$$

$$e(\mathbf{i})e(\mathbf{j}) = \delta_{\mathbf{i}, \mathbf{j}}e(\mathbf{i}), \quad (3.1.2)$$

$$y_r e(\mathbf{i}) = e(\mathbf{i})y_r, \quad (3.1.3)$$

$$\tau_r e(\mathbf{i}) = e(s_r(\mathbf{i}))\tau_r, \quad (3.1.4)$$

$$y_r y_t = y_t y_r, \quad (3.1.5)$$

$$\tau_r \tau_t = \tau_t \tau_r \quad \text{if } |r - t| > 1, \quad (3.1.6)$$

$$y_t \tau_r e(\mathbf{i}) = \begin{cases} (\tau_r y_{s_r(t)} + \delta_{t,r} - \delta_{t,r+1}) e(\mathbf{i}) & i_r = i_{r+1} \text{ and } t = r, r+1, \\ \tau_r y_{s_r(t)} e(\mathbf{i}) & \text{otherwise,} \end{cases} \quad (3.1.7a)$$

$$\tau_r^2 e(\mathbf{i}) = \begin{cases} 0 & i_r = i_{r+1}, \\ e(\mathbf{i}) & a_{i_r, i_{r+1}} = 0, \\ \left( y_r^{-a_{i_r, i_{r+1}}} + y_{r+1}^{-a_{i_{r+1}, i_r}} \right) e(\mathbf{i}) & a_{i_r, i_{r+1}} < 0, \end{cases} \quad (3.1.8a)$$

$$\tau_r^2 e(\mathbf{i}) = \begin{cases} 0 & i_r = i_{r+1}, \\ e(\mathbf{i}) & a_{i_r, i_{r+1}} = 0, \\ \left( y_r^{-a_{i_r, i_{r+1}}} + y_{r+1}^{-a_{i_{r+1}, i_r}} \right) e(\mathbf{i}) & a_{i_r, i_{r+1}} < 0, \end{cases} \quad (3.1.8b)$$

$$\left( y_r^{-a_{i_r, i_{r+1}}} + y_{r+1}^{-a_{i_{r+1}, i_r}} \right) e(\mathbf{i}) \quad a_{i_r, i_{r+1}} < 0, \quad (3.1.8c)$$

$$\tau_r \tau_{r+1} \tau_r e(\mathbf{i})$$

$$= \begin{cases} \left( \tau_{r+1} \tau_r \tau_{r+1} + \delta_{i_r, i_{r+2}} \sum_{t=0}^{-a_{i_r, i_{r+1}} - 1} y_r^t y_{r+2}^{-a_{i_r, i_{r+1}} - 1 - t} \right) e(\mathbf{i}) & a_{i_r, i_{r+1}} < 0, \\ \tau_{r+1} \tau_r \tau_{r+1} e(\mathbf{i}) & \text{otherwise.} \end{cases} \quad (3.1.9a)$$

$$\tau_{r+1} \tau_r \tau_{r+1} e(\mathbf{i}) \quad \text{otherwise.} \quad (3.1.9b)$$

The  $\mathbb{Z}$ -grading on  $R(\alpha)$  is given by

$$\deg(e(\mathbf{i})) = 0, \quad \deg(y_k e(\mathbf{i})) = (\alpha_{i_k}, \alpha_{i_k}), \quad \text{and} \quad \deg(\tau_k e(\mathbf{i})) = -(\alpha_{i_k}, \alpha_{i_{k+1}}). \quad (3.1.10)$$

**Remark 3.1.2.** The relations (3.1.1) and (3.1.2) say that the  $e(\mathbf{i})$ 's are a system of orthogo-

nal idempotents. We shall refer to the  $y_t$ 's and  $\tau_r$ 's as *polynomial* and *symmetric* generators, respectively.

Khovanov and Lauda have defined a diagrammatic calculus for  $R(\alpha)$  [KL09, KL11]. One considers braid-like diagrams in the plane where strands can carry dots and are colored by elements of  $I$ . Left multiplication is given by concatenating a diagram on top of another diagram when all the corresponding endpoints have matching colors, and is otherwise defined to be zero. The conversion between algebraic and graphical notations is as follows:

$$e(\mathbf{i}) \leftrightarrow \begin{array}{c} | \quad \dots \quad | \quad \dots \quad | \\ i_1 \quad \quad i_k \quad \quad i_m \end{array}, \tag{3.1.11}$$

$$y_r e(\mathbf{i}) \leftrightarrow \begin{array}{c} | \quad \dots \quad \bullet \quad \dots \quad | \\ i_1 \quad \quad i_r \quad \quad i_m \end{array}, \tag{3.1.12}$$

$$\tau_r e(\mathbf{i}) \leftrightarrow \begin{array}{c} | \quad \dots \quad \diagdown \quad \diagup \quad \dots \quad | \\ i_1 \quad \quad i_r \quad i_{r+1} \quad i_m \end{array}. \tag{3.1.13}$$

We place a number next to a dot to indicate that it occurs with a certain multiplicity. The relations (3.1.7a) through (3.1.9b) above correspond to the following local relations on diagrams:

$$\begin{array}{c} \bullet \\ \diagdown \quad \diagup \\ i \quad i \end{array} = \begin{array}{c} \diagdown \quad \diagup \\ i \quad i \end{array} + \begin{array}{c} | \quad | \\ i \quad i \end{array} \quad \text{and} \quad \begin{array}{c} \diagdown \quad \diagup \\ \bullet \\ i \quad i \end{array} = \begin{array}{c} \diagdown \quad \diagup \\ i \quad i \end{array} - \begin{array}{c} | \quad | \\ i \quad i \end{array}, \tag{3.1.14a}$$

$$\begin{array}{c} \bullet \\ \diagdown \quad \diagup \\ i \quad j \end{array} = \begin{array}{c} \diagdown \quad \diagup \\ i \quad j \end{array} \quad \text{and} \quad \begin{array}{c} \diagdown \quad \diagup \\ \bullet \\ i \quad j \end{array} = \begin{array}{c} \diagdown \quad \diagup \\ i \quad j \end{array} \quad \text{for } i \neq j, \tag{3.1.14b}$$



$$\begin{aligned}
 \text{cross}_{ij} &= \begin{cases} 0 & i = j, \\ \begin{array}{c} | \quad | \\ i \quad j \end{array} & a_{ij} = 0, \\ \begin{array}{c} | \quad | \\ -a_{ij} \bullet \quad | \\ i \quad j \end{array} + \begin{array}{c} | \quad | \\ | \quad -a_{ji} \bullet \\ i \quad j \end{array} & a_{ij} < 0, \end{cases} \tag{3.1.15a}
 \end{aligned}$$

$$\tag{3.1.15b}$$

$$\tag{3.1.15c}$$

$$\begin{aligned}
 \text{triple}_{ijk} &= \begin{cases} \begin{array}{c} \text{cross}_{ij} \text{ over } k \\ \text{cross}_{jk} \text{ over } i \end{array} + \delta_{i,k} \sum_{t=0}^{-a_{ij}-1} \begin{array}{c} | \quad | \quad | \\ \bullet \quad | \quad | \\ i \quad j \quad i \end{array} \begin{array}{c} | \\ -a_{ij}-1-t \bullet \\ i \end{array} & a_{ij} < 0, \\ \begin{array}{c} \text{cross}_{ij} \text{ over } k \\ \text{cross}_{jk} \text{ over } i \end{array} & \text{otherwise.} \end{cases} \tag{3.1.16a}
 \end{aligned}$$

$$\tag{3.1.16b}$$

**Example 3.1.3.** We consider the KLR algebra  $R(m\alpha_i)$  coming from any Cartan datum. An examination of the defining relations reveals that  $R(m\alpha_i)$  is isomorphic to the *nilHecke algebra*  $NH_m$ , which is the unital algebra of endomorphisms of  $\mathbb{Z}[y_1, \dots, y_m]$  generated by the operations of left-multiplication by  $y_1, \dots, y_m$  and by divided difference operators  $\partial_k$  given by

$$\partial_k(f) = \frac{f - s_k f}{y_k - y_{k+1}}$$

for all  $1 \leq k < m$ , where  $s_k$  swaps  $y_k$  with  $y_{k+1}$  for all polynomials  $f \in \mathbb{Z}[y_1, \dots, y_m]$ . The defining relations of  $NH_m$  over  $1 \leq r, t \leq m$  and  $1 \leq k, j < m$  are:

(1)  $y_r y_t = y_t y_r,$

$$(2) \partial_k \partial_j = \partial_j \partial_k \text{ and } \partial_k y_r = y_r \partial_k \text{ if } |r - j| > 1,$$

$$(3) \partial_k^2 = 0,$$

$$(4) \partial_k \partial_{k+1} \partial_k = \partial_{k+1} \partial_k \partial_{k+1}, \text{ and}$$

$$(5) y_k \partial_k - \partial_k y_{k+1} = \partial_k y_k - y_{k+1} \partial_k = 1.$$

The simple graded modules over such algebras play an important role in the theory and in this dissertation (see Section 4.1).

The algebra  $R(\alpha)$  decomposes as a direct sum of  $\mathbb{k}$ -vector spaces in several ways:

$$R(\alpha) = \bigoplus_{\mathbf{i} \in I^\alpha} R(\alpha) e(\mathbf{i}), \quad (3.1.17)$$

$$R(\alpha) = \bigoplus_{\mathbf{j} \in I^\alpha} e(\mathbf{j}) R(\alpha), \text{ and} \quad (3.1.18)$$

$$R(\alpha) = \bigoplus_{\mathbf{i}, \mathbf{j} \in I^\alpha} e(\mathbf{j}) R(\alpha) e(\mathbf{i}). \quad (3.1.19)$$

Diagrammatically,  $R(\alpha) e(\mathbf{i})$  is the  $\mathbb{k}$ -linear combinations of diagrams with  $\mathbf{i}$  at the bottom,  $e(\mathbf{j}) R(\alpha)$  is the  $\mathbb{k}$ -linear combinations of diagrams with  $\mathbf{j}$  at the top, and  $e(\mathbf{j}) R(\alpha) e(\mathbf{i})$  is the  $\mathbb{k}$ -linear combinations of diagrams with  $\mathbf{i}$  at the bottom and  $\mathbf{j}$  at the top.

The following can be found in [KL09, KL11, Rou08].

**Theorem 3.1.4** (Basis Theorem). *The algebra  $R(\alpha)$  has a basis of the form*

$$\{\tau_{\widehat{w}} y_1^{a_1} \cdots y_m^{a_m} e(\mathbf{i}) \mid \mathbf{i} \in I^\alpha, \widehat{w} \in [S_m], a_r \in \mathbb{Z}_{\geq 0} \text{ for all } 1 \leq r \leq m\}. \quad (3.1.20)$$

In diagrammatic terms one can think of these basis elements as having all crossings at the top and all dots at the bottom. It is clear from the relations that every element of  $R(\alpha)$

can be represented as a linear combination of elements of this form: for a given element, just apply the commutation relations to move all polynomial generators to the right and symmetric generators to the left. We describe an algorithm for doing this systematically in Section B.1. Showing the linear independence of such elements takes some work, and we direct the reader to the papers of Khovanov and Lauda for details [KL09, KL11].

**Example 3.1.5.** Consider any Cartan datum with a generalized Cartan matrix of rank at least 2. Let  $\alpha_1$  and  $\alpha_2$  be two simple roots. Then the KLR algebra  $R(\alpha_1 + \alpha_2)$  is generated by

$$e(12), \quad e(21), \quad y_1, \quad y_2, \quad \text{and } \tau_1.$$

It has an infinite basis given by elements of the form

$$y_1^{a_1} y_2^{a_2} e(12), \quad y_1^{a_1} y_2^{a_2} e(21), \quad \tau_1 y_1^{a_1} y_2^{a_2} e(12), \quad \text{and } \tau_1 y_1^{a_1} y_2^{a_2} e(21)$$

taken over all  $a_1, a_2 \in \mathbb{Z}_{\geq 0}$ . Diagrammatically these elements are, respectively,

$$\begin{array}{c} a_1 \\ | \\ \bullet \\ | \\ 1 \end{array} \quad \begin{array}{c} a_2 \\ | \\ \bullet \\ | \\ 2 \end{array}, \quad \begin{array}{c} a_1 \\ | \\ \bullet \\ | \\ 2 \end{array} \quad \begin{array}{c} a_2 \\ | \\ \bullet \\ | \\ 1 \end{array}, \quad \begin{array}{c} \diagup \quad \diagdown \\ \bullet \quad \bullet \\ \diagdown \quad \diagup \\ 1 \quad 2 \end{array}, \quad \text{and} \quad \begin{array}{c} \diagdown \quad \diagup \\ \bullet \quad \bullet \\ \diagup \quad \diagdown \\ 2 \quad 1 \end{array}.$$

## 3.2 Modules over KLR algebras

Let  $R(\alpha)\text{-mod}$  be the category of finitely generated graded left  $R(\alpha)$ -modules,  $R(\alpha)\text{-fmod}$  be the category of finite-dimensional graded  $R(\alpha)$ -modules, and  $R(\alpha)\text{-pmod}$  be the category of projective objects in  $R(\alpha)\text{-mod}$ . The gradings are over  $\mathbb{Z}$  and the morphisms in these categories are grading-preserving module homomorphisms.

Now form the direct sum

$$R := \bigoplus_{\alpha \in Q^+} R(\alpha).$$

The algebras  $R(\alpha)$  are indecomposable [KL09, Corollary 2.11], so they are the blocks of  $R$ .

We also define the following direct sums of categories of  $R(\alpha)$ -modules:

$$\begin{aligned} R\text{-mod} &:= \bigoplus_{\alpha \in Q^+} R(\alpha)\text{-mod}, \\ R\text{-fmod} &:= \bigoplus_{\alpha \in Q^+} R(\alpha)\text{-fmod}, \\ R\text{-pmod} &:= \bigoplus_{\alpha \in Q^+} R(\alpha)\text{-pmod}. \end{aligned}$$

We denote the zero module by  $\mathbf{0}$ . We refer to a basis of an  $R(\alpha)$ -module  $M$  as a *weight basis* if it respects the decomposition

$$M = \bigoplus_{i \in I^\alpha} e(\mathbf{i})M.$$

For  $M \in R(\alpha)\text{-mod}$  and  $r \in \mathbb{Z}$ , let  $M\langle r \rangle$  denote  $M$  with its grading shifted up by  $r$ . For a pair of modules  $M, N \in R(\alpha)\text{-mod}$ , denote by  $\text{Hom}_{R(\alpha)}(M, N)$  or  $\text{Hom}(M, N)$  the  $\mathbb{k}$ -vector space of degree-preserving homomorphisms, and by  $\text{Hom}(M\langle r \rangle, N) = \text{Hom}(M, N\langle -r \rangle)$  the space of homogeneous homomorphisms of degree  $r$ . Then we write

$$\text{HOM}(M, N) = \bigoplus_{r \in \mathbb{Z}} \text{Hom}(M, N\langle r \rangle), \quad (3.2.1)$$

for the  $\mathbb{Z}$ -graded  $\mathbb{k}$ -vector space of  $R(\alpha)$ -module morphisms.

**Remark 3.2.1.** While the gradings on modules are critical for the categorification theorem (see Section 3.4), we often only consider isomorphism classes of modules up to a shift in their

grading. If we wish to indicate that two modules are isomorphic and have the same grading, we shall write  $\cong$  to denote the isomorphism. If we wish to indicate that two modules are isomorphic only up to an integer shift in their grading, then we use  $\simeq$ .

### 3.3 Induction and restriction

For  $\alpha, \beta \in Q^+$ , there is an inclusion of graded algebras

$$\iota_{\alpha, \beta} : R(\alpha) \otimes R(\beta) \hookrightarrow R(\alpha + \beta).$$

This inclusion is given graphically by juxtaposing Khovanov-Lauda diagrams. Denote by  $e(\alpha)$  and  $e(\beta)$  the units of  $R(\alpha)$  and  $R(\beta)$ , respectively. Under the inclusion the idempotent  $e(\mathbf{i}) \otimes e(\mathbf{j})$  maps to  $e(\mathbf{ij})$  and the unit  $e(\alpha) \otimes e(\beta)$  maps to an idempotent of  $R(\alpha + \beta)$  which we call  $e(\alpha, \beta)$ . From the inclusion we obtain induction and restriction functors on the module categories:

$$\text{Ind}_{\alpha, \beta} : R(\alpha) \otimes R(\beta)\text{-mod} \rightarrow R(\alpha + \beta)\text{-mod}, \text{ and}$$

$$\text{Res}_{\alpha, \beta} : R(\alpha + \beta)\text{-mod} \rightarrow R(\alpha) \otimes R(\beta)\text{-mod}$$

given by

$$\text{Ind}_{\alpha, \beta} - := R(\alpha + \beta)e(\alpha, \beta) \otimes_{R(\alpha) \otimes R(\beta)} -, \text{ and} \tag{3.3.1}$$

$$\text{Res}_{\alpha, \beta} - := R(\alpha) \otimes R(\beta)e(\alpha, \beta) \otimes_{R(\alpha + \beta)} -. \tag{3.3.2}$$

For a module  $M \in R(\alpha)\text{-mod}$ , we use  $M^{ot}$  to denote a  $t$ -fold outer tensor induction product, i.e.

$$M^{ot} = \text{Ind} \underbrace{M \boxtimes \cdots \boxtimes M}_{t \text{ times}}.$$

The resulting module is in the category  $R(t\alpha)\text{-mod}$ .

We can generalize these notions to root lattice compositions. That is, if  $\alpha \in Q^+$  with composition  $\underline{\alpha} = (\alpha^{(1)}, \dots, \alpha^{(k)})$ , so  $\alpha = \alpha^{(1)} + \cdots + \alpha^{(k)}$ , then we define

$$\iota_{\underline{\alpha}} : R(\alpha^{(1)}) \otimes \cdots \otimes R(\alpha^{(k)}) \hookrightarrow R(\alpha).$$

Again one can think of this inclusion graphically as juxtaposing Khovanov-Lauda diagrams according to the order of the composition. We denote the corresponding induction and restriction functors by  $\text{Ind}_{\underline{\alpha}}$  and  $\text{Res}_{\underline{\alpha}}$ , respectively. When the composition is clear from context, we often simplify notation and write just  $\text{Ind}$  or  $\text{Res}$ .

We think of the image  $\text{Im } \iota_{\underline{\alpha}} \subseteq R(\alpha)$  as a parabolic subalgebra  $R(\underline{\alpha})$  with unit  $e(\underline{\alpha})$ . Let  $P$  be the integer composition  $(\text{ht}(\alpha^{(1)}), \dots, \text{ht}(\alpha^{(k)}))$  of  $\text{ht}(\alpha)$ . If  $M$  is an  $R(\underline{\alpha})$ -module with weight basis  $\mathcal{U}$ , then the  $R(\alpha)$ -module  $\text{Ind}_{\underline{\alpha}} M = R(\alpha) \otimes_{R(\underline{\alpha})} M$  has a weight basis of the form

$$\{\tau_{\widehat{w}} \otimes u \mid \widehat{w} \in [S_{\text{ht}(\alpha)} / S_P], u \in \mathcal{U}\}. \quad (3.3.3)$$

An important property of  $\text{Ind}$  is that it is left adjoint to  $\text{Res}$ , so we have (an analogue of) Frobenius reciprocity:

$$\text{HOM}_{R(\alpha)}(\text{Ind}_{\underline{\alpha}} A, B) \cong \text{HOM}_{R(\underline{\alpha})}(A, \text{Res}_{\underline{\alpha}} B) \quad (3.3.4)$$

where  $A$  and  $B$  are, respectively, finite-dimensional  $R(\underline{\alpha})$ - and  $R(\alpha)$ -modules.

### 3.4 Grothendieck groups and categorification

Let  $\mathcal{K}_0(R(\alpha)\text{-pmod})$  be the Grothendieck group of the category of finitely generated graded projective modules over  $R(\alpha)$ . Similarly, let  $\mathcal{G}_0(R(\alpha)\text{-fmod})$  denote the Grothendieck group of the category of finite-dimensional graded  $R(\alpha)$  modules. Now consider the following direct sums:

$$\begin{aligned}\mathcal{K}_0(R) &:= \bigoplus_{\alpha \in Q^+} \mathcal{K}_0(R(\alpha)\text{-pmod}), \\ \mathcal{G}_0(R) &:= \bigoplus_{\alpha \in Q^+} \mathcal{G}_0(R(\alpha)\text{-fmod}).\end{aligned}$$

We define an action by  $\mathcal{A} = \mathbb{Z}[q, q^{-1}]$  on elements  $[M]$  of  $\mathcal{K}_0(R)$  and  $\mathcal{G}_0(R)$  by grading shifts, i.e. for  $r \in \mathbb{Z}$  we have  $q^r \cdot [M] = [M\langle r \rangle]$ . Since the functors Ind and Res are exact, they may be considered as operators on  $\mathcal{K}_0(R)$  and  $\mathcal{G}_0(R)$ .

We can now state the categorification theorem. Let  ${}_{\mathcal{A}}\mathbf{U}_q^-(\mathfrak{g})^*$  denote the dual of  ${}_{\mathcal{A}}\mathbf{U}_q^-(\mathfrak{g})$  with respect to a certain non-degenerate bilinear form, which we shall not specify here exactly (see [KL11]).

**Theorem 3.4.1** ([Rou08, KL09, KL11]). *We have the following isomorphisms of twisted bialgebras:*

$$\begin{aligned}\mathcal{K}_0(R) &\cong {}_{\mathcal{A}}\mathbf{U}_q^-(\mathfrak{g}), \text{ and} \\ \mathcal{G}_0(R) &\cong {}_{\mathcal{A}}\mathbf{U}_q^-(\mathfrak{g})^*,\end{aligned}$$

where Ind and Res correspond, respectively, to multiplication and comultiplication in the quantum group.

### 3.5 Graded dimensions and characters

Let  $M \in R(\alpha)\text{-mod}$  and consider its graded decomposition

$$M = \bigoplus_{k \in \mathbb{Z}} M_k.$$

We define for  $M$

- its *graded dimension* by

$$\text{gdim}(M) = \sum_{k \in \mathbb{Z}} \dim(M_k) \cdot q^k,$$

- its *character* by

$$\text{ch}(M) = \sum_{\mathbf{i} \in I^\alpha} \dim(e(\mathbf{i})M) \cdot \mathbf{i},$$

- and its *graded character* by

$$\text{ch}_q(M) = \sum_{\mathbf{i} \in I^\alpha} \text{gdim}(e(\mathbf{i})M) \cdot \mathbf{i}.$$

In general the graded character is an element of the free  $\mathbb{Z}((q))$ -module with basis  $I^\alpha$ . When  $M \in R(\alpha)\text{-fmod}$ ,  $\text{ch}_q(M)$  is an element of the free  $\mathbb{Z}[q, q^{-1}]$ -module with basis  $I^\alpha$ . Notice that  $\text{ch}_q(M) = \text{ch}(M)$  when  $q = 1$ . The maps above can just as easily be defined as maps on the Grothendieck groups. In fact, we have the following important theorem.

**Theorem 3.5.1** ([KL09]). *For each  $\alpha \in Q^+$ , the graded character map*

$$\text{ch}_q : \mathcal{G}_0(R(\alpha)\text{-fmod}) \rightarrow \mathbb{Z}[q, q^{-1}]I^\alpha$$



is injective.

Let  $\mathbf{i} \in I^\alpha$  and  $\mathbf{j} \in I^\beta$ . For  $\mathbf{k} \in \text{Sh}(\mathbf{i}, \mathbf{j})$ , we denote by  $\text{deg}(\mathbf{i}, \mathbf{j}, \mathbf{k})$  the degree, as given in the definition of KLR algebras (see (3.1.10)), of the diagram associated to the shuffle as an element of  $R(\alpha + \beta)$ .

**Example 3.5.2.** We work with the KLR algebra  $R(5\alpha_1 + 4\alpha_2)$  defined using the Cartan datum associated to the generalized Cartan matrix

$$\begin{bmatrix} 2 & -3 \\ -3 & 2 \end{bmatrix}.$$

In the diagram below,  $\mathbf{k} = 112221121$  is a shuffle of  $\mathbf{i} = 121$  and  $\mathbf{j} = 122121$ . The degrees of crossings of colored strands are determined by the symmetric bilinear form defined in Section 2.1. The degree of the diagram is obtained by summing the degrees of all the crossings. We have indicated the degree of each crossing in the diagram.

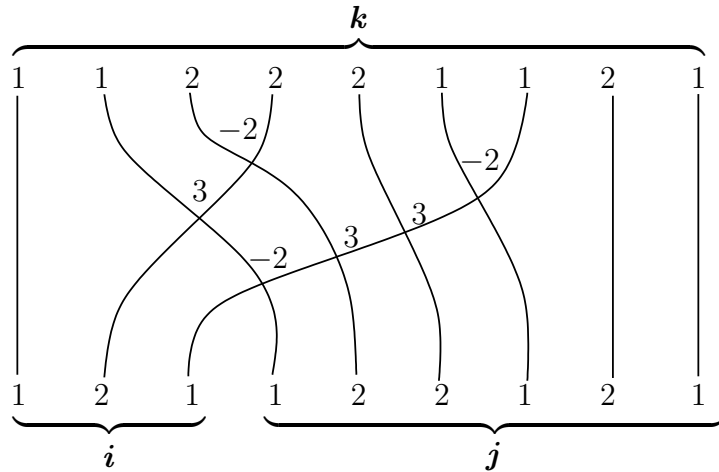

Summing up the numbers above the crossings, we see that  $\text{deg}(\mathbf{i}, \mathbf{j}, \mathbf{k}) = 3$ . This diagram is given in algebraic form by  $\tau_3\tau_2\tau_6\tau_5\tau_4\tau_3e(\mathbf{ij})$ .

Given  $M \in R(\alpha)\text{-mod}$  and  $N \in R(\beta)\text{-mod}$  we can construct their outer tensor  $M \boxtimes N$ , which is a  $R(\alpha) \otimes R(\beta)$ -module. Now let  $\omega$  denote the quantum shuffle product (with respect to  $\deg$ ) on the free module  $\mathbb{Z}[q, q^{-1}]\langle I \rangle$ . In the notation of (2.2.3), we have  $h_{i,j}(\mathbf{k}) = \deg(\mathbf{i}, \mathbf{j}, \mathbf{k})$ . It was shown in [KL09] that

$$\text{ch}_q(\text{Ind}_{\alpha,\beta}(M \boxtimes N)) = \text{ch}_q(M) \omega \text{ch}_q(N). \quad (3.5.1)$$

In other words, taking an induction product of KLR algebra modules corresponds to taking the quantum shuffle product of the corresponding graded characters. This makes the graded characters an extremely useful arithmetic device for studying modules over KLR algebras.

# Chapter 4

## Finite-dimensional Modules Over KLR algebras

In this chapter we review two classifications of finite-dimensional modules over KLR algebras. One corresponds to the  $B(\infty)$  crystal, and the other to the dual canonical basis.

### 4.1 Simple $R(m\alpha_i)$ -modules

From the theory of nilHecke algebras (see Example 3.1.3) it is known that a KLR algebra of the form  $R(m\alpha_i)$  has a unique graded simple module (up to degree shift), which we shall denote by  $L(i^m)$ . It can be described as the module induced from the 1-dimensional graded module  $T(i^m) := L(i) \boxtimes \cdots \boxtimes L(i)$ , which is an  $m$ -fold outer tensor product of the simple  $R(\alpha_i)$ -module. Identifying  $y_j$  with the polynomial generator of the  $j$ th factor, we see that  $T(i^m)$  is essentially a module over  $\mathbb{k}[y_1, \dots, y_m]$  on which  $y_1, \dots, y_m$  all act as 0. Let  $v(i^m)$  be the basis vector for  $T(i^m)$ . Then the Basis Theorem 3.1.4 implies that  $L(i^m) \simeq \text{Ind } T(i^m)$

has a basis of the form

$$B(i^m) := \{\tau_{\widehat{w}} \otimes v(i^m) \mid \widehat{w} \in [S_m]\}. \quad (4.1.1)$$

From this it is clear that the dimension of  $L(i^m)$  is  $m!$ . Hereafter, we set  $\deg v(i^m) = \frac{(m-1)m}{2}d_i$ , which determines a grading on  $L(i^m)$  so that

$$\mathrm{ch}_q(L(i^m)) = [m]_i! \cdot i^m. \quad (4.1.2)$$

**Remark 4.1.1.** Let  $u \in L(i^m)$ . In [HL10, Proposition 2.8], it is shown that  $y_r^k u = 0$  for all  $k \geq m$  and all  $1 \leq r \leq m$ . Moreover,  $m$  is minimal in the sense that for all  $1 \leq r \leq m$  there exists  $\tilde{u} \in L(i^m)$  such that  $y_r^{m-1} \tilde{u} \neq 0$ .

## 4.2 Crystal structure on modules

In this section we give a brief exposition of the identification of simple modules over KLR algebras with the  $B(\infty)$  crystal. This theory was first exhibited by Lauda and Vazirani in [LV11]. We work with an arbitrary Cartan datum.

Let  $\alpha \in Q^+$  and define functors

$$e_i : R(\alpha)\text{-mod} \rightarrow R(\alpha - \alpha_i)\text{-mod}, \quad \text{and}$$

$$f_i : R(\alpha)\text{-mod} \rightarrow R(\alpha + \alpha_i)\text{-mod}$$

by

$$e_i(M) = \mathrm{Res}_{\alpha - \alpha_i}^{\alpha_i, \alpha - \alpha_i} (e(\alpha_i, \alpha - \alpha_i)M), \quad \text{and} \quad (4.2.1)$$

$$f_i(M) = R(\alpha + \alpha_i)e(\alpha_i, \alpha) \otimes_{R(\alpha)} M. \quad (4.2.2)$$

When considered as operators on  $R\text{-pmod}$  or  $R\text{-fmod}$ , these functors are exact, so they also give operators on the Grothendieck groups  $\mathcal{K}_0(R)$  and  $\mathcal{G}_0(R)$ . In fact, they satisfy the (quantum) Serre relations:

$$\sum_{k=0}^{1-a_{ij}} (-1)^k e_i^{(1-a_{ij}-k)} e_j e_i^{(k)} [M] = 0, \quad (4.2.3)$$

$$\sum_{k=0}^{1-a_{ij}} (-1)^k f_i^{(1-a_{ij}-k)} f_j f_i^{(k)} [M] = 0, \quad (4.2.4)$$

where  $i, j \in I$  and for  $n \in \mathbb{Z}_{\geq 0}$

$$e_i^{(n)} [M] := \frac{1}{[n]_i!} [e_i^n M], \text{ and} \quad (4.2.5)$$

$$f_i^{(n)} [M] := \frac{1}{[n]_i!} [f_i^n M]. \quad (4.2.6)$$

We also define the following for  $M \in R(\alpha)\text{-fmod}$ :

$$\text{wt}(M) = -\alpha, \quad (4.2.7)$$

$$\varepsilon_i(M) = \max\{k \geq 0 \mid e_i^k M \neq 0\}, \quad (4.2.8)$$

$$\varphi_i(M) = \varepsilon_i(M) + \langle h_i, \text{wt}(M) \rangle, \quad (4.2.9)$$

$$\tilde{e}_i(M) = \text{soc}(e_i M), \text{ and} \quad (4.2.10)$$

$$\tilde{f}_i(M) = \text{hd Ind}_{\alpha_i, \alpha}(L(i) \boxtimes M). \quad (4.2.11)$$

Let  $\mathbb{B}(\infty)$  be the set of isoclasses of simple graded  $R$ -modules, and denote by  $\mathbb{1}$  the 1-dimensional trivial  $R(0)$  module. It follows that the set  $\mathbb{B}(\infty)$ , together with the maps  $\text{wt}, \varepsilon_i, \varphi_i, \tilde{e}_i$ , and  $\tilde{f}_i$  ( $i \in I$ ) comprise a crystal in the sense of Definition 2.4.1. In fact, we have the following theorem.

**Theorem 4.2.1** ([LV11]). *The  $B(\infty)$  crystal of  $\mathbf{U}_q^-(\mathfrak{g})$  is isomorphic to  $\mathbb{B}(\infty)$ .*

This amounts to a construction and parameterization of all simple  $R$ -modules in terms of  $B(\infty)$ . In practice, however, this yields little information about the structure of simple modules since taking the head of a module (when applying  $\tilde{f}_i$ ) is typically a nontrivial operation. Lauda and Vazirani [LV11] have given some insight into the structure of certain families of modules under their construction. Of particular importance in their proof of the crystal isomorphism are the “Jump Lemma” and the “Structure Theorems” of simple  $R(c\alpha_i + \alpha_j)$ -modules where  $c \in \mathbb{Z}_{>0}$  and  $i, j \in I$  such that  $i \neq j$ .

**Lemma 4.2.2** (Jump Lemma). *Let  $M$  be a simple  $R$ -module and let  $i \in I$ . The following are equivalent:*

- $\text{Ind } M \boxtimes L(i) \simeq \text{Ind } L(i) \boxtimes M$ ,
- $\text{Ind } M \boxtimes L(i^m) \simeq \text{Ind } L(i^m) \boxtimes M$  for all  $m \geq 1$ ,
- $\text{Ind } M \boxtimes L(i)$  is simple,
- $\text{Ind } L(i) \boxtimes M$  is simple,
- $\text{Ind } M \boxtimes L(i^m)$  is simple for all  $m \geq 1$ ,
- $\text{Ind } L(i^m) \boxtimes M$  is simple for all  $m \geq 1$ .

There are actually many more equivalent conditions, but the ones listed here will be sufficient for our purposes. We make the following definition.

**Definition 4.2.3.** A simple  $R$ -module  $M$  satisfying the equivalent conditions of Lemma 4.2.2 is called an  *$i$ -jump module*.

Now let  $i, j \in I$  with  $i \neq j$  and set  $a = -\langle h_i, \alpha_j \rangle$ . The first Structure Theorem follows.

**Theorem 4.2.4** ([LV11]). *Let  $c \leq a$ . Up to isomorphism and grading shift, there exists a unique simple  $R(c\alpha_i + \alpha_j)$ -module, which we denote by  $\mathcal{L}(i^n j i^{c-n})$ , satisfying*

$$\varepsilon_i(\mathcal{L}(i^n j i^{c-n})) = n$$

for every  $0 \leq n \leq c$ . Moreover, for a particular choice of grading, we have

$$\text{ch}_q(\mathcal{L}(i^n j i^{c-n})) = [n]_i! [c-n]_i! \cdot i^n j i^{c-n}.$$

We distinguish the case when  $c = a$ : for  $0 \leq n \leq a$  set  $\mathcal{L}(n) = \mathcal{L}(i^n j i^{a-n})$ . Such modules turn out to be  $i$ -jump modules.

**Theorem 4.2.5** ([LV11]). *Let  $0 \leq n \leq a$ .*

1. *For all  $m \geq 0$ , we have*

$$\text{Ind } L(i^m) \boxtimes \mathcal{L}(n) \simeq \text{Ind } \mathcal{L}(n) \boxtimes L(i^m).$$

*In particular,  $\text{Ind } L(i^m) \boxtimes \mathcal{L}(n)$  is simple for all  $m \geq 0$ .*

2. *Let  $c \geq a$  and let  $N$  be a simple  $R(c\alpha_i + \alpha_j)$ -module satisfying  $\varepsilon_i(N) = n$ . Then  $c - a \leq n \leq c$  and*

$$N \simeq \text{Ind } L(i^{c-a}) \boxtimes \mathcal{L}(n - (c - a)).$$

These theorems provide us with a good understanding of the structure of the modules described. In particular, we can compute their characters using the quantum shuffle product (see (3.5.1)).

Benkart, Kang, Oh, and Park [BKOP14] have further illuminated the structure of simple

modules constructed via crystal induction. We review their work, starting with results that apply for all Cartan types.

For  $1 \leq k \leq n$  let  $I_{(k)}$  be a subset of  $I$  such that  $|I_{(k)}| = k$ . Assume also that  $I_{(k)} \subset I_{(k+1)}$  for all  $1 \leq k < n$ , and let  $\mathfrak{B}_k$  be the crystal graph obtained from  $B(\infty)$  by forgetting the  $i$ -arrows for  $i \notin I_{(k)}$ .

**Lemma 4.2.6** ([BKOP14]). *For each  $1 \leq k \leq n$ , every connected component of  $\mathfrak{B}_k$  has a unique highest weight vector.*

Let  $b \in B(\infty)$ . Set  $u_0 = b$ , and for  $1 \leq k \leq n$ , let  $u_k$  be the highest weight vector of the connected component of  $\mathfrak{B}_k$  which contains  $b$ . In particular, for  $1 \leq k \leq n$  we have

$$u_{k-1} = \tilde{f}_{i_1} \tilde{f}_{i_2} \dots \tilde{f}_{i_\ell} u_k$$

for some sequence  $\mathbf{i}_k = (i_1, \dots, i_\ell) \in I_{(k)}^\ell$ . We may shorten the notation and write

$$u_{k-1} = \tilde{f}_{\mathbf{i}_k} u_k,$$

where it is understood that  $\tilde{f}_{\mathbf{i}_k} = \tilde{f}_{i_1} \tilde{f}_{i_2} \dots \tilde{f}_{i_\ell}$ .

Let  $\mathbb{1}$  be the 1-dimensional simple  $R(0)$ -module and for  $1 \leq k \leq n$  define

$$\mathcal{N}_k(b) = \tilde{f}_{\mathbf{i}_k} \mathbb{1},$$

where  $\tilde{f}_i$  is the crystal operator on modules as in (4.2.11).

**Theorem 4.2.7** ([BKOP14]). *Let  $\Phi : B(\infty) \rightarrow \mathbb{B}(\infty)$  be the crystal isomorphism implicit*



in Theorem 4.2.1 and let  $b \in B(\infty)$ . Then

$$\Phi(b) = \text{hd } \text{Ind } \mathcal{N}_1(b) \boxtimes \cdots \boxtimes \mathcal{N}_n(b).$$

This refinement of the crystal isomorphism sheds some light on the structure of simple modules constructed via crystal induction. In finite types we can refine this result further by describing the  $\mathcal{N}_k(b)$ 's in terms of Littelmann's adapted strings [Lit98].

Suppose we are working with a finite type Cartan datum. Let  $W$  be the corresponding Weyl group. Denote by  $s_i$  for  $i \in I$  the simple reflections and let  $w_0$  be the longest element of  $W$ . If  $\ell$  is the length of  $w_0$ , then  $w_0$  has an expression of the form

$$w_0 = \mathbf{s}_1 \mathbf{s}_2 \cdots \mathbf{s}_n = s_{i_1} s_{i_2} \cdots s_{i_\ell},$$

where  $\mathbf{s}_j$  for all  $1 \leq j \leq n$  is a sequence as in Table A.1.1.

**Definition 4.2.8.** Let  $b \in B(\infty)$ . An  $\ell$ -tuple  $\mathbf{a}(b) = (a_1, \dots, a_\ell) \in \mathbb{Z}_{\geq 0}^\ell$  is called the *adapted string* of  $b$  with respect to  $w_0 = s_{i_1} s_{i_2} \cdots s_{i_\ell}$  if it satisfies

$$a_j = \varepsilon_{i_j}(\tilde{e}_{i_{j-1}}^{a_{j-1}} \cdots \tilde{e}_{i_1}^{a_1} b)$$

for all  $1 \leq j \leq \ell$ .

We denote the set of all adapted strings of elements in  $B(\infty)$  by

$$\mathcal{S} = \{\mathbf{a}(b) \mid b \in B(\infty)\}.$$

The map  $\mathcal{S} \rightarrow B(\infty)$  given by  $\mathbf{a} = (a_1, \dots, a_\ell) \mapsto \tilde{f}_{i_1}^{a_1} \cdots \tilde{f}_{i_\ell}^{a_\ell} \mathbf{1}$  is one-to-one. For all  $1 \leq k \leq$

$n$ , let  $\ell_k$  be the length of  $\mathbf{s}_k$ . If  $\mathbf{a} = (a_1, \dots, a_\ell)$ , we set

$$\mathbf{a}_{k,j} = a_{\ell_1 + \dots + \ell_{k-1} + j} \quad \text{and} \quad \mathbf{a}_k = (\mathbf{a}_{k,1}, \dots, \mathbf{a}_{k,\ell_k}).$$

Letting  $*$  denote concatenation, we see that  $\mathbf{a} = \mathbf{a}_1 * \dots * \mathbf{a}_n$ . If  $\mathbf{s}_k = s_{j_1} \dots s_{j_{\ell_k}}$ , put

$$\tilde{f}_{\mathbf{s}_k}^{\mathbf{a}_k} = \tilde{f}_{j_1}^{\mathbf{a}_{k,1}} \dots \tilde{f}_{j_{\ell_k}}^{\mathbf{a}_{k,\ell_k}}.$$

Then for  $b \in B(\infty)$ , we have  $\mathbf{a}(b) = \mathbf{a}(b)_1 * \dots * \mathbf{a}(b)_n$  so that

$$b = \tilde{f}_{s_1}^{\mathbf{a}(b)_1} \dots \tilde{f}_{s_n}^{\mathbf{a}(b)_n} 1.$$

Littelmann has explicitly described the sets  $\mathcal{S}$  for all finite types in terms of inequalities on the  $\mathbf{a}_{k,j}$ 's [Lit98], which provide a convenient parameterization of  $B(\infty)$ . On the KLR side we obtain a finer description of the  $\mathcal{N}_k(b)$ 's.

**Proposition 4.2.9** ([BKOP14]). *Let  $b \in B(\infty)$  and let  $\mathbf{a}(b) = \mathbf{a}(b)_1 * \dots * \mathbf{a}(b)_n$  be the adapted string of  $b$  with respect to  $w_0 = \mathbf{s}_1 \dots \mathbf{s}_n$ . If we set  $I_{(k)} = \{1, \dots, k\}$ , then*

$$\mathcal{N}_k(b) = \tilde{f}_{s_k}^{\mathbf{a}(b)_k} \mathbb{1}$$

for all  $1 \leq k \leq n$ .

Even more can be said in the finite classical types  $A_n, B_n, C_n$  and  $D_n$ . We will not give all the details as it will take us too far afield, but the interested reader can see more in [BKOP14]. We caution that our labeling of the Dynkin diagrams in Table A.1.1 differs from the labeling in [BKOP14].

TABLE 4.2.1: Dynkin diagram walks

Type	Graph
$A_n$	$1 \longrightarrow 2 \longrightarrow \cdots \longrightarrow n-1 \longrightarrow n$
$B_n$	$n \longrightarrow n-1 \longrightarrow \cdots \longrightarrow 2 \longrightarrow 1 \longrightarrow 1 \longrightarrow 2 \longrightarrow \cdots \longrightarrow n$
$C_n$	$n \longrightarrow n-1 \longrightarrow \cdots \longrightarrow 2 \longrightarrow 1 \longrightarrow 2 \longrightarrow \cdots \longrightarrow n$
$D_n$	$  \begin{array}{ccccccc}  & & & & 2 & \longrightarrow & 1 \\  & & & & \nearrow & & \searrow \\  n & \longrightarrow & n-1 & \longrightarrow & \cdots & \longrightarrow & 3 \\  & & & & \searrow & & \nearrow \\  & & & & 1 & \longrightarrow & 2 \\  & & & & & & \searrow \\  & & & & & & 3 & \longrightarrow & \cdots & \longrightarrow & n  \end{array}  $

Consider the oriented graphs organized by classical Cartan type in Table 4.2.1. A *walk* on one of these graphs is a path starting at some node that follows the direction of the arrows and ends at some node (possibly the same node). We denote a walk (following the arrows) on one of these oriented graphs as a word  $\mathbf{w}$  in the nodes visited. For example,  $\mathbf{w} = 5432132$  is such a walk in type  $D_5$ . For a walk  $\mathbf{w} = w_1 w_2 \dots w_m$ , we define

$$\Delta_{\mathbf{w}} = \tilde{f}_{\mathbf{w}} \mathbb{1} = \tilde{f}_{w_1} \tilde{f}_{w_2} \dots \tilde{f}_{w_m} \mathbb{1}.$$

The resulting simple modules are always 1- or 2-dimensional, and they are easy to describe. See Section 5.3 for explicit descriptions.

Taken over all walks  $\mathbf{w}$ , the simple modules  $\Delta_{\mathbf{w}}$  serve as building blocks of the classification of simple modules in finite classical types. More precisely, for  $b \in B(\infty)$ , there are modules  $\Delta(\mathbf{a}(b), k)$  defined as specific outer tensor products of  $\Delta_{\mathbf{w}}$ 's, and these modules

satisfy

$$\mathcal{N}_k(b) \simeq \text{hd Ind } \Delta(\mathbf{a}(b), k)$$

for all  $1 \leq k \leq n$ . This leads to the following refinement of the crystal isomorphism.

**Theorem 4.2.10** ([BKOP14]). *For a Cartan datum of finite classical type, let  $b \in B(\infty)$ , let  $\mathbf{a}(b)$  be the adapted string of  $b$  with respect to the expression  $w_0 = \mathbf{s}_1 \dots \mathbf{s}_n$  given in Table A.1.1, and let  $\Delta(\mathbf{a}(b)) = \Delta(\mathbf{a}(b), 1) \boxtimes \dots \boxtimes \Delta(\mathbf{a}(b), n)$ . Then  $\text{hd Ind } \Delta(\mathbf{a}(b))$  is simple, and the map  $\Psi : B(\infty) \rightarrow \mathbb{B}(\infty)$  given by*

$$\Psi(b) = \text{hd Ind } \Delta(\mathbf{a}(b))$$

*is a crystal isomorphism. In particular, if  $\mathcal{S}$  is the set of adapted strings, then  $\{\text{hd Ind } \Delta(\mathbf{a}) \mid \mathbf{a} \in \mathcal{S}\}$  is the complete list of all simple  $R$ -modules up to isomorphism and grading shift.*

**Remark 4.2.11.** We have focused on the case of  $\mathbb{B}(\infty)$  in this section, but [LV11] and [BKOP14] also develop the crystal theory for modules over cyclotomic KLR algebras. These algebras categorify highest weight modules over quantum groups [KK12, Web13].

**Remark 4.2.12.** We have parameterized the building blocks in finite classical type in terms of walks on the graphs in Table 4.2.1, but in [BKOP14] the blocks are parameterized using certain highest weight crystals. The resulting module constructions are the same.

### 4.3 Standard module theory

In this section we work with a Cartan datum of finite type. Several different bases of  $\mathbf{U}_q^-(\mathfrak{g})$  have been studied, perhaps the most important of which is the canonical (or lower global) basis of Lusztig and Kashiwara. There is also a PBW-type basis as in [Lus10]. One can

consider the duals of these bases with respect to certain non-degenerate bilinear forms on  $\mathbf{U}_q(\mathfrak{g})$ .

In this section, we shall review the standard module theory for KLR algebras. To each positive root we associate a simple *cuspidal* module. Standard modules are defined as (ordered) induction products of induction powers of cuspidal modules. Under the isomorphism of Theorem 3.4.1, the cuspidal modules correspond to dual PBW basis elements. The most economical development of standard module theory for finite type KLR algebras was given by McNamara [McN15], whose exposition we now outline.

Fix a choice of reduced expression of the longest element of the Weyl group:

$$w_0 = s_{i_1} s_{i_2} \dots s_{i_N}.$$

This determines an ordering of the positive roots:

$$\beta_1 = \alpha_{i_1} < \beta_2 = s_{i_1}(\alpha_{i_2}) < \dots < \beta_N = s_{i_1} \dots s_{i_{N-1}}(\alpha_{i_N}).$$

This ordering is *convex* in the sense that if  $\gamma_1$  and  $\gamma_2$  are positive roots such that  $\gamma_1 < \gamma_2$  and  $\gamma_1 + \gamma_2$  is also a positive root, then

$$\gamma_1 < \gamma_1 + \gamma_2 < \gamma_2.$$

In fact, it can be shown that all convex orderings of the positive roots arise from some choice of reduced expression of  $w_0$ .

To each  $\beta_k$  there is a PBW basis element  $E_{\beta_k}$ . Products  $E_{\beta_1}^{(m_1)} E_{\beta_2}^{(m_2)} \dots E_{\beta_N}^{(m_N)}$  of divided powers form an  $\mathcal{A} = \mathbb{Z}[q, q^{-1}]$  basis of  ${}_{\mathcal{A}}\mathbf{U}_q^-(\mathfrak{g})$ . Moreover, we can define dual PBW basis elements  $E_{\beta_k}^*$  with respect to a certain non-degenerate bilinear form, whose ordered products

of divided powers form an  $\mathcal{A}$  basis of  ${}_{\mathcal{A}}\mathbf{U}_q^-(\mathfrak{g})^*$ .

**Theorem 4.3.1** ([McN15]). *To each positive root  $\beta_k$ , there is an associated simple module  $S_{\beta_k}$  such that*

1.  $S_{\beta_k}$  corresponds to  $E_{\beta_k}^*$  under Theorem 3.4.1,
2. for every  $\mathbf{m} = (m_1, m_2, \dots, m_N) \in \mathbb{Z}_{\geq 0}^N$ , the module

$$\Delta(\mathbf{m}) := \text{Ind } S_{\beta_1}^{\circ m_1} \boxtimes \dots \boxtimes S_{\beta_N}^{\circ m_N}$$

has a unique simple quotient  $L(\mathbf{m})$ , and

3. the simple modules  $L(\mathbf{m})$  for  $\mathbf{m} \in \mathbb{Z}_{\geq 0}^N$  form a complete and irredundant set of representatives of isomorphism classes of simple modules over  $R$ .

The  $S_{\beta_k}$ 's are called *cuspidal modules*, and the  $\Delta(\mathbf{m})$ 's are called (*proper*) *standard modules*. While McNamara's development of the theory is very general, his definition of the cuspidal modules is not explicit. Prior to McNamara's work, Kleshchev and Ram developed a theory of standard modules that is considerably more explicit, albeit slightly less general [KR11]. We describe their theory next.

Begin by fixing a total order on  $I$ . This induces a lexicographical ordering on  $\langle I \rangle$ . The quantum group  $\mathbf{U}_q^-(\mathfrak{g})$  and its dual  $\mathbf{U}_q^-(\mathfrak{g})^*$  embed into a quantum shuffle  $\mathbb{Q}(q)$ -algebra whose basis is  $\langle I \rangle$  and whose product is an associative quantum shuffle product  $\omega$  [Lec04]. A word in  $\langle I \rangle$  is called *good* if it is the maximal word appearing in the image of some element  $x \in \mathbf{U}_q^-(\mathfrak{g})^*$  under the quantum shuffle embedding. A word is called *Lyndon* if it is smaller than all of its proper right factors.

**Lemma 4.3.2** ([LR95],[Lec04],[KR11]). *The positive roots of  $\mathfrak{g}$  are in one-to-one correspondence with good Lyndon words. Moreover, every good word  $\mathbf{i}$  has a canonical factorization*

$$\mathbf{i} = (\mathbf{j}_1)^{n_1} (\mathbf{j}_2)^{n_2} \dots (\mathbf{j}_N)^{n_N}$$

*into a product of powers of good Lyndon words in which*

$$\mathbf{j}_1 > \mathbf{j}_2 > \dots > \mathbf{j}_N.$$

This lemma allows us to transport the ordering on good Lyndon words to an ordering on positive roots, which we call the *Lyndon ordering*. One can show that this is a convex ordering of the positive roots.

Let  $\mathcal{G}$  be the set of good words. The image  $\{b_{\mathbf{i}}^* \mid \mathbf{i} \in \mathcal{G}\}$  of the dual canonical basis under the quantum shuffle embedding is labeled by good words (see [Lec04]). Let  $\mathbf{i}$  be a good word with factorization as in Lemma 4.3.2 and let  $\beta_k$  be the positive root corresponding to the good Lyndon word  $\mathbf{j}_k$  for all  $1 \leq k \leq N$ . Recall that the graded characters of KLR algebra modules lie in  $\mathbb{Z}[q, q^{-1}]\langle I \rangle$ , so they can be interpreted as elements of the quantum shuffle algebra. To each  $\beta_k$ , there is an associated simple module  $L_{\beta_k}$  satisfying

$$\mathrm{ch}_q L_{\beta_k} = b_{\mathbf{j}_k}^*.$$

Modules of the form  $L_{\beta_k}$  are the cuspidal modules in the standard module theory of Kleshchev and Ram. They have been constructed explicitly in most cases with respect to a certain choice of ordering on  $I$  [Kle14, Section 8]. Hill, Melvin, and Mondragon have also constructed many cuspidal modules explicitly, but with a different choice of ordering [HMM12]. See Section 5.4 for constructions of cuspidal modules.

**Remark 4.3.3.** The standard module theory has been extended to some affine types (see [\[Kle14\]](#), [\[McN14\]](#)). For arbitrary symmetrizable types, Tingley and Webster [\[TW13\]](#) have defined the notions of convex pre-orders and semi-cuspidal modules. They have shown that the semi-cuspidals serve as building blocks for constructing all simple modules, but there is no explicit description of these modules.



# Chapter 5

## Simple Monoweight Modules

In this chapter we provide a uniform construction for a class of simple modules over KLR algebras coming from an arbitrary Cartan datum. From these simple modules one may obtain with little effort most of the building blocks of the finite type classifications outlined in the preceding sections. Outside of finite type we obtain an infinite number of such modules.

### 5.1 Construction and first properties

We work over an arbitrary Cartan datum and an algebraically closed field  $\mathbb{k}$ . Let  $\alpha \in Q^+$ , let  $\mathbf{i} = i_1^{n_1} i_2^{n_2} \dots i_k^{n_k} \in I^\alpha$ , and let  $T(\mathbf{i}) = L(i_1^{n_1}) \boxtimes \dots \boxtimes L(i_k^{n_k})$ . Note that  $T(\mathbf{i})$  is simple as an  $R(n_1 \alpha_{i_1}) \otimes \dots \otimes R(n_k \alpha_{i_k})$ -module. By (4.1.1) and (4.1.2) we know that each  $L(i_j^{n_j})$  has a basis  $B(i_j^{n_j})$  of cardinality  $n_j!$  and has graded character  $[n_j]_{i_j}! \cdot i_j^{n_j}$ . Let

$$\{u_{p_j}^{(n_j)} \mid 1 \leq p_j \leq n_j!\}$$

be the elements of the basis  $B(i_j^{n_j})$  for  $1 \leq j \leq k$ . Then  $T(\mathbf{i})$  has a basis

$$B_1(\mathbf{i}) = \{u_{p_1}^{(1)} \otimes \cdots \otimes u_{p_k}^{(k)} \mid 1 \leq p_j \leq n_j!, 1 \leq j \leq k\}.$$

Now consider  $\text{Ind } T(\mathbf{i})$ . It is an  $R(\alpha)$ -module with a basis of the form

$$B_2(\mathbf{i}) = \{\tau_{\widehat{w}} \otimes u \mid \widehat{w} \in [S_{\ell(\mathbf{i})}/S_{n_1} \times \cdots \times S_{n_k}], u \in B_1(\mathbf{i})\}.$$

We define a subset of  $B_2(\mathbf{i})$  as follows:

$$K(\mathbf{i}) := \{\tau_{\widehat{w}} \otimes u \in B_2(\mathbf{i}) \mid \ell(\widehat{w}) > 0\}.$$

Note that if  $\ell(\widehat{w}) = 0$ , then  $\widehat{w}$  is a trivial shuffle so that  $\tau_{\widehat{w}} \otimes u \in B_2(\mathbf{i})$  is identified with  $u \in B_1(\mathbf{i})$ .

**Theorem 5.1.1.** *Set  $M(\mathbf{i}) = \text{span}_{\mathbb{k}} K(\mathbf{i})$ . Then  $M(\mathbf{i})$  with the induced action of  $R(\alpha)$  is the unique maximal submodule of  $\text{Ind } T(\mathbf{i})$  if and only if the following conditions hold on  $\mathbf{i}$ :*

- (1)  $a_{i_r, i_{r+1}} \neq 0$  for all  $1 \leq r < k$ ,
- (2)  $n_r \leq -a_{i_r, i_{r+1}}$  and  $n_{r+1} \leq -a_{i_{r+1}, i_r}$  for all  $1 \leq r < k$ , and
- (3)  $n_r + n_{r+2} \leq -a_{i_r, i_{r+1}}$  whenever  $i_r = i_{r+2}$  and  $n_{r+1} = 1$ .

*Proof.* Assume first that  $\mathbf{i}$  satisfies properties (1), (2), and (3). Take  $\tau_{\widehat{w}} \otimes u \in K(\mathbf{i})$  and an arbitrary generator  $x$  of  $R(\alpha)$ . We will show that  $x \cdot \tau_{\widehat{w}} \otimes u \in \text{span}_{\mathbb{k}} K(\mathbf{i})$ . If  $x = e(\mathbf{j})$  for some  $\mathbf{j} \in I^\alpha$ , then

$$x \cdot \tau_{\widehat{w}} \otimes u = \delta_{\mathbf{j}, w(\mathbf{i})} \tau_{\widehat{w}} \otimes u \in \text{span}_{\mathbb{k}} K(\mathbf{i}).$$

Now assume  $x$  is a polynomial or symmetric generator of  $R(\alpha)$ . We know that

$$x \cdot \tau_{\widehat{w}} \otimes u = \sum a_i(\tau_{\widehat{w}_i} \otimes u_i) \in \text{span}_{\mathbb{k}} B_2(\mathbf{i}); \tag{5.1.1}$$

i.e. there is a set of KLR algebra relations which, when applied to the left-hand side of (5.1.1), produces the right-hand side.

Seeking a contradiction, suppose that some nonzero term on the right hand side of (5.1.1) has  $\widehat{w}_j$  with length zero. This means, in particular, that in the process of applying KLR relations which turn  $x \cdot \tau_{\widehat{w}} \otimes u$  into  $\sum a_i(\tau_{\widehat{w}_i} \otimes u_i)$ , some single relation is applied to a term of the form  $a(\tau_{\nu} \otimes u') \in \text{span}_{\mathbb{k}} K(\mathbf{i})$  where  $\tau_{\nu} = \tau_{\nu'}\tau_q$  with  $q \in \{n_1, n_1 + n_2, \dots, n_1 + \dots + n_{k-1}\}$ , and it results in a nonzero term of the form  $k(e(\mathbf{i}) \otimes u'')$  for some  $k \in \mathbb{k}$ , which is not in  $\text{span}_{\mathbb{k}} K(\mathbf{i})$ .

Let us examine  $\tau_{\nu} \otimes u'$ , where we write  $u' = u_1 \otimes \dots \otimes u_k$ . We can visualize this element as one of the following diagrams, where  $\tau_q$  corresponds to the indicated crossing:

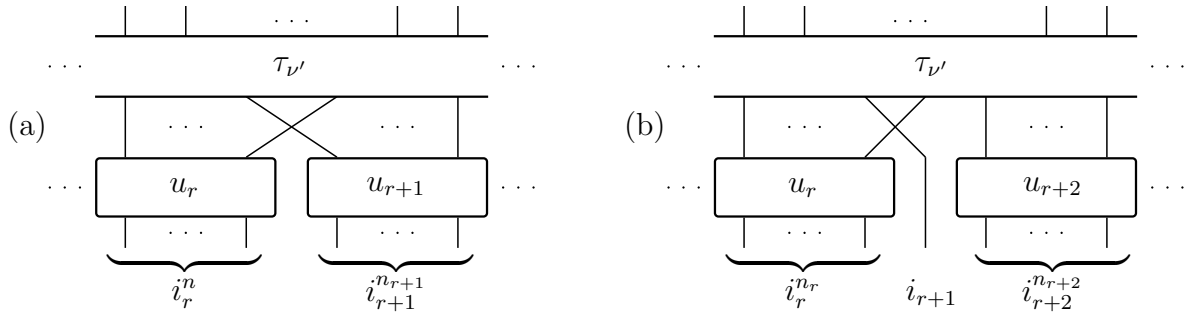

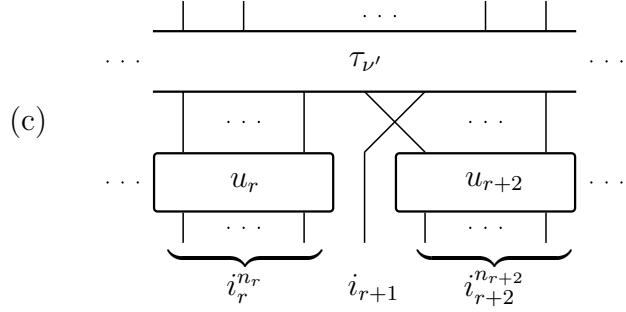

Suppose that  $\tau_{\nu} \otimes u'$  has the form indicated in diagram (a) or (b). The only KLR relations which could potentially remove  $\tau_q$  and leave behind a nonzero term are (3.1.7a), (3.1.8b), (3.1.8c), and (3.1.9a). Relation (3.1.7a) does not apply since  $i_r \neq i_{r+1}$ , and relation (3.1.8b) does not apply by condition (1). If we apply relation (3.1.8c), condition (2) and Remark 4.1.1 guarantee that  $y_q^{-a_{i_r, i_{r+1}}}$  and  $y_{q+1}^{-a_{i_{r+1}, i_r}}$  will kill the elements  $u_r \in L(i_r^{n_r})$  and  $u_{r+1} \in L(i_{r+1}^{n_{r+1}})$  which lie beneath  $\tau_q$ . If we have diagram (b), condition (3) of the theorem and Remark 4.1.1 guarantee that each term of the sum

$$\sum_{t=0}^{-a_{i_r, i_{r+1}} - 1} y_q^t y_{q+2}^{-a_{i_r, i_{r+1}} - 1 - t}$$

will kill at least one of  $u_r \in L(i_r^{n_r})$  or  $u_{r+2} \in L(i_{r+2}^{n_{r+2}})$ . Similar arguments hold in the case of diagram (c). Thus we see it is impossible that  $k(e(\mathbf{i}) \otimes u'') \neq 0$ , a contradiction.

Thus far we have shown that conditions (1), (2), and (3) of the theorem guarantee that  $M(\mathbf{i})$  is a proper submodule of  $\text{Ind } T(\mathbf{i})$ . This is a maximal submodule since any nonzero element outside of  $M(\mathbf{i})$  can be identified with a nonzero element of  $T(\mathbf{i})$ , and the irreducibility of  $T(\mathbf{i})$  guarantees that every such element is a generator of  $T(\mathbf{i})$ , hence also a generator of  $\text{Ind } T(\mathbf{i})$ . We also see that any other proper submodule of  $\text{Ind } T(\mathbf{i})$  must be contained in  $M(\mathbf{i})$ , giving uniqueness.

To get the “only if” part of the theorem, we show that excluding any one of conditions (1), (2), or (3) will result in  $\text{span}_{\mathbb{k}} K(\mathbf{i})$  *not* being a proper submodule of  $\text{Ind } T(\mathbf{i})$ .

Suppose that condition (1) fails. Let  $u = u_1 \otimes \cdots \otimes u_k$  be a nonzero element in  $T(\mathbf{i})$ , and let  $q$  be such that  $\tau_q$  is the crossing above  $u_r$  and  $u_{r+1}$  for  $\tau_q \otimes u \in \text{Ind } T(\mathbf{i})$ . Then there is some consecutive pair of indices  $i_r$  and  $i_{r+1}$  in  $\mathbf{i}$  such that  $a_{i_r, i_{r+1}} = 0$ . It follows that

$$\tau_q \cdot \tau_q \otimes u = \tau_q^2 \otimes u = e(\mathbf{i}) \otimes u = 1 \otimes u,$$

by relation (3.1.8b), which clearly is not in  $\text{span}_{\mathbb{k}} K(\mathbf{i})$ .

Now suppose that condition (2) fails. Choose  $u$  and  $\tau_q$  as above. Then

$$\begin{aligned} \tau_q \cdot \tau_q \otimes u &= (y_q^{-a_{i_r, i_{r+1}}} + y_{q+1}^{-a_{i_{r+1}, i_r}}) e(\mathbf{i}) \otimes u \\ &= u_1 \otimes \cdots \otimes y_q^{-a_{i_r, i_{r+1}}} u_r \otimes \cdots \otimes u_k \\ &\quad + u_1 \otimes \cdots \otimes y_{q+1}^{-a_{i_{r+1}, i_r}} u_{r+1} \otimes \cdots \otimes u_k \end{aligned}$$

by relation (3.1.8c). Since  $n_r > -a_{i_r, i_{r+1}}$  or  $n_{r+1} > -a_{i_{r+1}, i_r}$ , Remark 4.1.1 says we can choose  $u_r$  or  $u_{r+1}$  such that  $y_q^{-a_{i_r, i_{r+1}}} u_r \neq 0$  or  $y_{q+1}^{-a_{i_{r+1}, i_r}} u_{r+1} \neq 0$ . In either case,  $\tau_q^2 \otimes u$  fails to be in  $\text{span}_{\mathbb{k}} K(\mathbf{i})$ .

Lastly, suppose that condition (3) fails, and that we have  $\tau_q \otimes u$  as in diagram (b) with  $\tau_{q'} = 1$ . Then

$$\begin{aligned} \tau_q \tau_{q+1} \cdot \tau_q \otimes u &= (\tau_{q+1} \tau_q \tau_{q+1} + \sum_{t=0}^{-a_{i_r, i_{r+1}}-1} y_q^t y_{q+2}^{-a_{i_r, i_{r+1}}-1-t}) e(\mathbf{i}) \otimes u \\ &= \tau_{q+1} \tau_q \tau_{q+1} \otimes u \\ &\quad + \left( \sum_{t=0}^{-a_{i_r, i_{r+1}}-1} y_q^t y_{q+2}^{-a_{i_r, i_{r+1}}-1-t} \right) \otimes u. \end{aligned}$$

There exists some  $t \geq 0$  such that  $t < n_r$  and  $-a_{i_r, i_{r+1}} - 1 - t < n_{r+2}$ . By Remark 4.1.1, for this  $t$  we can take  $u_r$  and  $u_{r+2}$  such that  $y_q^t u_r \neq 0$  and  $y_{q+2}^{-a_{i_r, i_{r+1}}-1-t} u_{r+2} \neq 0$ . In particular,

$\tau_q \tau_{q+1} \tau_q \otimes u \notin \text{span}_{\mathbb{k}} K(\mathbf{i})$ .

□

**Remark 5.1.2.** We point out that conditions (1), (2), and (3) of Theorem 5.1.1 assure that the word  $\mathbf{i}$  is such that application of the quantum Serre relations is avoided. That is, the exponents  $n_1, \dots, n_k$  are small enough that (4.2.3) and (4.2.4) do not apply.

**Remark 5.1.3.** Inspecting the conditions (1), (2), and (3) of Theorem 5.1.1, we see that the words  $\mathbf{i} = i_1^{n_1} \dots i_k^{n_k} \in \langle I \rangle$  satisfying these conditions may be interpreted as walks (with multiplicity) on the corresponding Dynkin diagram. More precisely, condition (1) says that  $i_r$  is connected to  $i_{r+1}$  in the Dynkin diagram for all  $1 \leq r < k$ , and conditions (2) and (3) indicate how many “steps” one can take while staying at a particular node of the Dynkin diagram during a walk. See Example 5.2.4.

**Corollary 5.1.4.** *Suppose that  $\mathbf{i}$  is a word in  $\langle I \rangle$  on which conditions (1), (2) and (3) of Theorem 5.1.1 hold, and let  $M(\mathbf{i})$  be as in the theorem. Then the quotient module  $\text{Ind } T(\mathbf{i})/M(\mathbf{i})$  is simple and, up to grading shift,*

$$\text{ch}_q(\text{Ind } T(\mathbf{i})/M(\mathbf{i})) = [n_1]_{i_1}! [n_2]_{i_2}! \dots [n_k]_{i_k}! \cdot \mathbf{i}.$$

*Proof.* Simplicity is clear by the maximality of  $M(\mathbf{i})$ . The character formula follows from equation (4.1.2) and the fact that all elements remaining after taking the quotient can be identified with elements of  $T(\mathbf{i})$ .

□

**Definition 5.1.5.** Let  $\mathbf{i}$  be a word in  $\langle I \rangle$  on which conditions (1), (2) and (3) of Theorem 5.1.1 hold. Then we say that  $\mathbf{i}$  is a *monoweight word* and we refer to the simple

module

$$L(\mathbf{i}) := \text{Ind } T(\mathbf{i})/M(\mathbf{i})$$

as the *simple monoweight module* corresponding to  $\mathbf{i}$ .

Note that Theorem 5.1.1 and its corollary amount to a generalization of Theorem 4.2.4, the first Structure Theorem of Lauda and Vazirani.

The next result says we can “factor” monoweight modules in a suitable sense.

**Corollary 5.1.6.** *Suppose  $\mathbf{i} \in \langle I \rangle$  is a monoweight word. Suppose that  $\mathbf{k}, \mathbf{j} \in \langle I \rangle$  such that  $\mathbf{i} = \mathbf{k}\mathbf{j}$ . Put  $M'(\mathbf{i}) = \text{span}_{\mathbb{k}} K(\mathbf{i}) \cap \text{Ind } L(\mathbf{j}) \boxtimes L(\mathbf{k})$ . Then  $M'(\mathbf{i})$  is a  $R(|\mathbf{i}|)$ -submodule of  $\text{Ind } L(\mathbf{j}) \boxtimes L(\mathbf{k})$  and*

$$L(\mathbf{i}) \simeq \text{Ind } L(\mathbf{j}) \boxtimes L(\mathbf{k})/M'(\mathbf{i}).$$

*Proof.* Repeat the arguments in the proof of Theorem 5.1.1 . □

## 5.2 Monoweight $i$ -jump modules

Recall the definition of  $i$ -jump modules from Definition 4.2.3. We shall now see that there is a precise condition on monoweight words  $\mathbf{i} \in \langle I \rangle$  which guarantees when the corresponding monoweight module  $L(\mathbf{i})$  is an  $i$ -jump module for some  $i \in I$ .

**Definition 5.2.1.** For  $i \in I$  set  $i^0 = \emptyset$  (the empty word). We say that

$$\mathbf{i} = i^{m_1} j_1 i^{m_2} j_2 \dots i^{m_{r-1}} j_{r-1} i^{m_r}$$

is the  $i$ -writing of a word  $\mathbf{i} \in \langle I \rangle$  if  $m_k \geq 0$  and  $i \neq j_k$  for all  $1 \leq k < r$ .

**Example 5.2.2.** Suppose  $I = \{1, 2\}$  and let  $\mathbf{i} = 111221 \in \langle I \rangle$ . Then the 1-writing of  $\mathbf{i}$  is  $1^3 21^0 21^1$ .

**Proposition 5.2.3.** Let  $\mathbf{i} = i_1^{n_1} \dots i_k^{n_k} \in \langle I \rangle$  such that  $L(\mathbf{i})$  is a monoweight module. Suppose that  $i^{m_1} j_1 i^{m_2} j_2 \dots i^{m_{s-1}} j_{s-1} i^{m_s}$  is the  $i$ -writing of  $\mathbf{i}$ . Then  $L(\mathbf{i})$  is an  $i$ -jump module if and only if  $m_r + m_{r+1} = -a_{ij_r}$  for all  $1 \leq r < s$ .

*Proof.* First suppose that  $L(\mathbf{i})$  is an  $i$ -jump module. By the Jump Lemma, we know that

$$\text{Ind } L(i) \boxtimes L(\mathbf{i}) \simeq \text{Ind } L(\mathbf{i}) \boxtimes L(i).$$

In particular, by injectivity of the character map (see Theorem 3.5.1), there exists some  $c \in \mathbb{Z}$  such that

$$q^c \text{ch}_q \text{Ind } L(i) \boxtimes L(\mathbf{i}) = \text{ch}_q \text{Ind } L(\mathbf{i}) \boxtimes L(i).$$

Using Corollary 5.1.4 and the quantum shuffle product (see (2.2.3)), we can compute characters on both sides of this equation. On the left, we have

$$q^c \cdot i \omega ([n_1]_{i_1}! \dots [n_k]_{i_k}! \cdot \mathbf{i}) = q^c [n_1]_{i_1}! \dots [n_k]_{i_k}! \cdot (i \omega \mathbf{i}),$$

and on the right

$$([n_1]_{i_1}! \dots [n_k]_{i_k}! \cdot \mathbf{i}) \omega i = q^c [n_1]_{i_1}! \dots [n_k]_{i_k}! \cdot (\mathbf{i} \omega i),$$

which tells us that

$$q^c \cdot (i \omega \mathbf{i}) = (\mathbf{i} \omega i).$$

Let us focus now on  $i \omega \mathbf{i}$  and  $\mathbf{i} \omega i$ . Recall the definition of the grading on KLR algebras



from (3.1.10). Let  $(x_{ij})_{i,j \in I} = (-\langle \alpha_i, \alpha_j \rangle)_{i,j \in I}$ . Put  $M_b = \sum_{a=1}^b m_a$  and  $X_b = \sum_{a=1}^b x_{ij_a}$ .

Then

$$\begin{aligned}
i \wr \mathbf{i} &= i \wr i^{m_1} j_1 i^{m_2} j_2 \dots i^{m_{s-1}} j_{s-1} i^{m_s} \\
&= (1 + q^{x_{ii}} + q^{2x_{ii}} + \dots + q^{M_1 x_{ii}}) \cdot i^{m_1+1} j_1 i^{m_2} j_2 \dots i^{m_{s-1}} j_{s-1} i^{m_s} \\
&+ (q^{M_1 x_{ii} + X_1} + \dots + q^{M_2 x_{ii} + X_1}) \cdot i^{m_1} j_1 i^{m_2+1} j_2 \dots i^{m_{s-1}} j_{s-1} i^{m_s} \\
&\vdots \\
&+ (q^{M_{s-1} x_{ii} + X_{s-1}} + \dots + q^{M_s x_{ii} + X_{s-1}}) \cdot i^{m_1} j_1 \dots j_{s-1} i^{m_s+1}.
\end{aligned}$$

Likewise, if we put  $M'_b = \sum_{a=b}^s m_a$  and  $X'_b = \sum_{a=b}^{s-1} x_{ij_a}$ , then

$$\begin{aligned}
\mathbf{i} \wr i &= i^{m_1} j_1 i^{m_2} j_2 \dots i^{m_{s-1}} j_{s-1} i^{m_s} \wr i \\
&= (1 + q^{x_{ii}} + q^{2x_{ii}} + \dots + q^{M'_s x_{ii}}) \cdot i^{m_1} j_1 i^{m_2} j_2 \dots i^{m_{s-1}} j_{s-1} i^{m_s+1} \\
&+ (q^{M'_s x_{ii} + X'_{s-1}} + \dots + q^{M'_{s-1} x_{ii} + X'_{s-1}}) \cdot i^{m_1} j_1 i^{m_2} j_2 \dots i^{m_{s-1}+1} j_{s-1} i^{m_s} \\
&\vdots \\
&+ (q^{M'_2 x_{ii} + X'_1} + \dots + q^{M'_1 x_{ii} + X'_1}) \cdot i^{m_1+1} j_1 \dots j_{s-1} i^{m_s}.
\end{aligned}$$

Examining the powers of  $q$  in the leading terms of each weight on both sides of  $q^c \cdot (i \wr \mathbf{i}) =$

$i \omega i$ , we find that the following system of equations must hold:

$$\begin{aligned}
c &= M'_2 x_{ii} + X'_1 \\
c + M_1 x_{ii} + X_1 &= M'_3 x_{ii} + X'_2 \\
c + M_2 x_{ii} + X_2 &= M'_4 x_{ii} + X'_3 \\
&\vdots \\
c + M_{s-2} x_{ii} + X_{s-2} &= M'_s x_{ii} + X'_{s-1} \\
c + M_{s-1} x_{ii} + X_{s-1} &= 0.
\end{aligned}$$

Consider any consecutive pair of these equations:

$$c + M_{r-1} x_{ii} + X_{r-1} = M'_{r+1} x_{ii} + X'_r \quad (5.2.1)$$

$$c + M_r x_{ii} + X_r = M'_{r+2} x_{ii} + X'_{r+1} \quad (5.2.2)$$

with  $1 \leq r < s$  and where we declare for convenience that  $M_0 = X_0 = M'_{s+1} = X'_s = 0$ .

Notice that subtracting (5.2.1) from (5.2.2) gives

$$(M_r - M_{r-1})x_{ii} + (X_r - X_{r-1}) = (M'_{r+2} - M'_{r+1})x_{ii} + (X'_{r+1} - X'_r),$$

or

$$m_r x_{ii} + x_{ij_r} = -m_{r+1} x_{ii} - x_{ij_r},$$

which reduces to

$$m_r + m_{r+1} = -2 \frac{x_{ij_r}}{x_{ii}} = -a_{ij_r},$$

as we wanted to show.

To go in the opposite direction, assume  $m_r + m_{r+1} = -a_{ij_r}$  for all  $1 \leq r < s$  and put  $c = M'_2 x_{ii} + X'_1$ . Running the argument backwards, it follows that

$$q^c \text{ch}_q \text{Ind } L(i) \boxtimes L(\mathbf{i}) = \text{ch}_q \text{Ind } L(\mathbf{i}) \boxtimes L(i),$$

which implies that

$$\text{Ind } L(i) \boxtimes L(\mathbf{i}) \simeq \text{Ind } L(\mathbf{i}) \boxtimes L(i).$$

Applying the Jump Lemma gives that  $L(\mathbf{i})$  is an  $i$ -jump module. □

Recall from the Jump Lemma that if  $M$  is a simple  $i$ -jump module, then we have an infinite list of simple modules of the form  $\text{Ind } L(i^m) \boxtimes M$  for all  $m \in \mathbb{Z}_{\geq 0}$ . Moreover, if we know the character of  $M$ , we may compute explicitly the character of  $\text{Ind } L(i^m) \boxtimes M$  using the quantum shuffle product.

**Example 5.2.4.** We work in type  $B_5$ , with the Dynkin diagram labeled as follows:

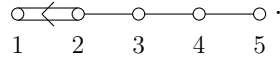

Observe that  $\mathbf{i} = 543211234$  is a monoweight word, so we can form the simple monoweight module  $L(\mathbf{i})$ . We claim that  $L(\mathbf{i})$  is also a 1-jump module. To see this, we form the 1-writing of  $\mathbf{i}$ :

$$1^0 5 1^0 4 1^0 3 1^0 2 1^2 2 1^0 3 1^0 4 1^0.$$

Note that the sum of powers of 1 next to a non-1 is always 0, except when 1 is next to 2, in which case the sum of powers is 2. Since the Cartan integer  $a_{1j} = 0$  for  $j \neq 1, 2$  and  $a_{12} = -2$ , we see that the 1-writing of  $\mathbf{i}$  satisfies the hypotheses of Proposition 5.2.3. We

get immediately that  $\text{Ind } L(1^m) \boxtimes L(\mathbf{i})$  is simple for all  $m \geq 0$ . Let us now compute the character of  $\text{Ind } L(1) \boxtimes L(\mathbf{i})$ :

$$\begin{aligned}
\text{ch}_q \text{Ind } L(1) \boxtimes L(\mathbf{i}) &= \text{ch}_q L(1) \omega \text{ch}_q L(\mathbf{i}) \\
&= 1 \omega [2]_1! \cdot 543211234 \\
&= [2]_1! \cdot (1543211234 + 5143211234 + 541321123 \\
&\quad + 5431211234 + (q^2 + 1 + q^{-2}) \cdot 5432111234 \\
&\quad + 5432112134 + 5432112314 + 5432112341) \\
&= [2]_1! \cdot (1543211234 + 5143211234 + 541321123 \\
&\quad + 5431211234 + 5432112134 + 5432112314 + 5432112341) \\
&\quad + [3]_1! \cdot 5432111234.
\end{aligned}$$

### 5.3 Building blocks of crystal theory

In this section and the next, we show that in most cases the building blocks of the classifications of simple finite-dimensional modules over KLR algebras of finite type are simple monoweight modules or can be obtained easily using simple monoweight modules. We remark that, although slightly different definitions of KLR algebras are given in [BKOP14] and [KR11], our proof of Theorem 5.1.1 works for their definitions with only minor modifications.

We adopt the notation of Section 4.2, where  $\mathbf{w} = w_1 w_2 \dots w_m$  denotes a word in the nodes visited for a walk on a graph in Table 4.2.1. We consider  $\mathbf{w}$  as an element of  $\langle I \rangle$ .

In type  $A_n$ ,  $B_n$  (if  $\mathbf{w}$  does not contain two 1s),  $C_n$  and  $D_n$  (if  $\mathbf{w}$  does not contain both

1 and 2),  $\Delta_{\mathbf{w}}$  is the  $R(|\mathbf{w}|)$ -module  $\mathbb{k}v$  with action

$$y_i v = 0, \quad \tau_j v = 0, \quad e(\mathbf{i})v = \delta_{\mathbf{i}, \mathbf{w}} v,$$

for all  $1 \leq i \leq m$ , all  $1 \leq j \leq m - 1$ , and all  $\mathbf{i} \in I^{|\mathbf{w}|}$ . From this description, we see easily that if we choose  $v$  to have degree 0, then  $\text{ch}_q \Delta_{\mathbf{w}} = \mathbf{w}$ . We see that  $\mathbf{w}$  is a monoweight word (see Definition 5.1.5). By comparing graded characters, the monoweight module  $L(\mathbf{w})$  is isomorphic to  $\Delta_{\mathbf{w}}$ .

In type  $B_n$ , when  $\mathbf{w}$  contains two 1s (they are necessarily adjacent), we let  $d$  be the index where the first 1 appears. Then  $\Delta_{\mathbf{w}}$  is the  $R(|\mathbf{w}|)$ -module  $\mathbb{k}u \oplus \mathbb{k}v$  with action

$$y_i u = \tau_j v = 0, \quad \tau_j u = \delta_{j,d} v, \quad y_i v = (\delta_{i,d+1} - \delta_{i,d}) u, \quad e(\mathbf{i})u = \delta_{\mathbf{i}, \mathbf{w}} u, \quad e(\mathbf{i})v = \delta_{\mathbf{i}, \mathbf{w}} v,$$

for all  $1 \leq i \leq m$ , all  $1 \leq j \leq m - 1$ , and all  $\mathbf{i} \in I^{|\mathbf{w}|}$ . If we choose  $u$  to have degree 1, then  $v$  has degree  $-1$ , and it follows immediately that  $\text{ch}_q \Delta_{\mathbf{w}} = [2]_1! \cdot \mathbf{w}$ . Again,  $\mathbf{w}$  is a monoweight word, and  $\text{ch}_q L(\mathbf{w}) = [2]_1! \cdot \mathbf{w}$ , so we see that  $L(\mathbf{w}) \cong \Delta_{\mathbf{w}}$ .

In type  $D_n$ , when  $\mathbf{w}$  contains both 1 and 2 (necessarily adjacent), let  $d$  be the index where the first occurs, and let  $\mathbf{w}'$  be the word obtained by swapping 1 and 2. Then  $\Delta_{\mathbf{w}}$  is the  $R(|\mathbf{w}|)$ -module  $\mathbb{k}u \oplus \mathbb{k}v$  with action defined by

$$y_i u = y_i v = 0, \quad \tau_j u = \delta_{j,d} v, \quad \tau_j v = \delta_{j,d} u, \quad e(\mathbf{i})u = \delta_{\mathbf{i}, \mathbf{w}} u, \quad e(\mathbf{i})v = \delta_{\mathbf{i}, \mathbf{w}'} v,$$

for all  $1 \leq i \leq m$ , all  $1 \leq j \leq m - 1$ , and all  $\mathbf{i} \in I^{|\mathbf{w}|}$ . If we choose  $u$  to have degree 0, then  $v$  has degree 0, and it follows immediately that  $\text{ch}_q \Delta_{\mathbf{w}} = \mathbf{w} + \mathbf{w}'$ .

There are two distinct words in the character, so of course  $\Delta_{\mathbf{w}}$  is not isomorphic to any simple monoweight module. However, we can still construct  $\Delta_{\mathbf{w}}$  using simple monoweight

modules, as follows. We put

$$\mathbf{i} = w_1 w_2 \dots w_d, \text{ and } \mathbf{j} = w_{d+1} w_{d+2} \dots w_m.$$

It is clear that  $L(\mathbf{i})$  and  $L(\mathbf{j})$  are 1-dimensional simple monoweight modules. Now consider  $\text{Ind } L(\mathbf{i}) \boxtimes L(\mathbf{j})$  and let  $v_{\mathbf{w}}$  be the basis element which is the tensor product of the bases of  $L(\mathbf{i})$  and  $L(\mathbf{j})$ . It is straightforward to show that  $\text{Ind } L(\mathbf{i}) \boxtimes L(\mathbf{j})$  has a proper submodule  $M(\mathbf{w})$  spanned by elements of the form  $\tau_{\widehat{x}} \tau_d v_{\mathbf{w}}$  in which  $\ell(\widehat{x}) > 0$ . It follows that

$$\Delta_{\mathbf{w}} \simeq \text{Ind } L(\mathbf{i}) \boxtimes L(\mathbf{j}) / M(\mathbf{w}).$$

## 5.4 Building blocks of standard module theory

In this section we examine the cuspidal modules constructed by Kleshchev and Ram in [KR11, Section 8]. Their labeling of the Dynkin diagrams for types  $A_n$ ,  $B_n$ ,  $C_n$ ,  $D_n$ ,  $F_4$ , and  $G_2$  matches our labeling in Table A.1.1. This is important since the choice of labeling corresponds to the choice of ordering on  $I$ , which determines the convex Lyndon ordering on positive roots.

In type  $A_n$  the positive roots are  $\alpha_{i,j}$  for  $1 \leq i \leq j \leq n$  as in Table A.2.1. We let  $\mathbf{w}$  be the word whose letters (in order) are  $i, i+1, \dots, j$ . Then the corresponding cuspidal module is 1-dimensional and is given by  $L(\mathbf{w})$ . Taken over all positive roots, this accounts for all cuspidal modules.

In type  $B_n$  the positive roots have the form  $\alpha_{i,j}$  for and  $\beta_{i,j}$  as in Table A.2.1. The cuspidal module associated to each  $\alpha_{i,j}$  is 1-dimensional and constructed exactly as above in type  $A_n$ . The cuspidal module associated to  $\beta_{1,j}$  is 2-dimensional and given by  $L(112 \dots j)$ .

To get the cuspidal associated to  $\beta_{i,j}$  with  $i > 1$  (up to a shift of grading), we defer to [KR11, Section 8.5], in which Kleshchev and Ram construct it by first forming the  $R(\alpha_1) \otimes R(\alpha_{1,j} + \alpha_{2,i})$ -module

$$\text{Ind}_{\alpha_1, \alpha_{1,j}, \alpha_{2,i}}^{\alpha_1, \alpha_{1,j} + \alpha_{2,i}} (\text{Res}_{\alpha_1, \alpha_{1,j}} L(112 \dots j)) \boxtimes L(23 \dots i),$$

then extending the action carefully to  $R(\beta_{i,j})$ .

For type  $C_n$  we consider now the positive roots  $\alpha_{i,j}$  and  $\beta_{i,j}$  as in Table A.2.1. The cuspidal module for each  $\alpha_{i,j}$  is constructed in the same way as in type  $A_n$ . The cuspidal associated to each  $\beta_{i,j}$  (up to a shift in grading) is given by first forming the  $R(\alpha_1) \otimes R(\alpha_{2,j} + \alpha_{2,i})$ -module

$$L(1) \boxtimes (\text{Ind } L(23 \dots j) \boxtimes L(23 \dots i)),$$

then extending the action to  $R(\beta_{i,j})$  by making  $\tau_1$  and all  $e(\mathbf{i})$  with  $i_1 \neq 1$  act as 0 (see [KR11, Section 8.6]).

In type  $D_n$  the positive roots  $\alpha_{i,j}$  and  $\beta_i$  as in Table A.2.1 correspond to 1-dimensional cuspiduals which we can construct as simple monoweights as in type  $A_n$ . See [KR11, Section 8.6] for the construction of cuspidal modules corresponding to the roots  $\gamma_{i,j}$ . These are part of a class of *homogeneous* modules, which have been studied first by Kleshchev and Ram in [KR10], and also by Feinberg and Lee [FL15].

In type  $E_6$ ,  $E_7$ , and  $E_8$  we note that Kleshchev and Ram use a different labeling of the Dynkin diagram than we do in Table A.1.1. In particular, they use the following (Bourbaki) convention.

Type	Dynkin diagram
$E_6$	
$E_7$	
$E_8$	

They have shown that almost all of the cuspidals in type  $E$  are, in fact, homogeneous modules. Note that the cuspidals for all roots which live in a sub-Dynkin diagram of type  $A$  or  $D$  can be constructed from monoweight modules as above.

In type  $F_4$ , Kleshchev and Ram construct cuspidals for roots lying in sub-Dynkin diagrams by using the previous constructions for types  $A$ ,  $B$ , and  $C$ . The cuspidal corresponding to the root  $\alpha_1 + \alpha_2 + \alpha_3 + \alpha_4$  is the simple monoweight module  $L(1234)$ . There are 9 roots remaining for which Kleshchev and Ram give no construction of the corresponding cuspidal module.

We handle type  $G_2$  in Section [6.1.3](#).



# Chapter 6

## Modules Over Rank 2 KLR Algebras

Using the crystal isomorphism of Theorem [4.2.1](#), we have a construction of all the simple modules for a KLR algebra coming from an arbitrary Cartan datum. However, this construction tells us little about the structure of these simple modules.

Typically there are many ways to get to each vertex in the crystal graph (see Section [2.4](#)). For arbitrary rank 2 cases, Nakashima and Zelevinsky [[NZ97](#)], and Littelmann [[Lit98](#)], have parameterized these paths as lattice points in certain polyhedra. Combined with the crystal isomorphism in Theorem [4.2.1](#), this gives us a finer parameterization of all the simples. Unfortunately, it is still difficult to know much about the explicit structure of a simple module given its parameterization, other than perhaps some (not very useful) upper and lower bounds on dimension.

In this chapter we apply the results of Chapter [5](#) to construct simple modules for many rank 2 examples. In finite types we can construct all the building blocks of existing classification schemes by using simple monoweight modules. In infinite types we can construct infinitely many simple modules whose characters are known immediately or can be computed.

## 6.1 Finite type

In all cases we let  $\alpha_1$  and  $\alpha_2$  denote the simple roots.

### 6.1.1 Type $A_2$

We work with the Cartan datum coming from the generalized Cartan matrix

$$\begin{bmatrix} 2 & -1 \\ -1 & 2 \end{bmatrix}.$$

For all  $m > 0$  the simple monoweight modules are  $L(1^m)$ ,  $L(2^m)$ ,  $L(12)$ , and  $L(21)$ . The monoweight 1-jump modules are  $L(1^m)$ ,  $L(12)$  and  $L(21)$ , and the monoweight 2-jump modules are  $L(2^m)$ ,  $L(12)$ , and  $L(21)$ .

We can take  $L(1)$ ,  $L(2)$ , and  $L(12)$  as building blocks for constructing all simple modules in the crystal theory (see Section 4.2). Moreover, these modules give all the cuspidals in the case of standard module theory (see Section 4.3).

### 6.1.2 Type $B_2$

We work with the Cartan datum coming from the generalized Cartan matrix

$$\begin{bmatrix} 2 & -2 \\ -1 & 2 \end{bmatrix}.$$

For all  $m > 0$  the simple monoweight modules are  $L(1^m)$ ,  $L(2^m)$ ,  $L(12)$ ,  $L(121)$ ,  $L(112)$ ,  $L(21)$ ,  $L(211)$ , and  $L(2112)$ . The 1-jump modules are  $L(1^m)$ ,  $L(121)$ ,  $L(112)$ ,  $L(211)$ , and

$L(2112)$ . The 2-jump modules are  $L(2^m)$ ,  $L(12)$ ,  $L(121)$ ,  $L(21)$ , and  $L(2112)$ .

The modules  $L(1)$ ,  $L(2)$ ,  $L(12)$ ,  $L(112)$ ,  $L(21)$ ,  $L(211)$ , and  $L(2112)$  are building blocks for the crystal classification. The positive roots are  $\alpha_1$ ,  $\alpha_2$ ,  $\alpha_1 + \alpha_2$ , and  $2\alpha_1 + \alpha_2$  (see Table A.2.1), and the corresponding cuspidal modules are exactly  $L(1)$ ,  $L(2)$ ,  $L(12)$ , and  $L(112)$ .

### 6.1.3 Type $G_2$

We work with the Cartan datum coming from the generalized Cartan matrix

$$\begin{bmatrix} 2 & -3 \\ -1 & 2 \end{bmatrix}.$$

For all  $m > 0$  the simple monoweight modules are  $L(1^m)$ ,  $L(2^m)$ ,  $L(12)$ ,  $L(121)$ ,  $L(1211)$ ,  $L(12112)$ ,  $L(121121)$ ,  $L(112)$ ,  $L(1121)$ ,  $L(1112)$ ,  $L(21)$ ,  $L(211)$ ,  $L(2111)$ ,  $L(21112)$ ,  $L(2112)$ , and  $L(21121)$ . The 1-jump modules are  $L(1^m)$ ,  $L(1211)$ ,  $L(121121)$ ,  $L(1121)$ ,  $L(1112)$ ,  $L(2111)$ , and  $L(21112)$ . The 2-jump modules are  $L(2^m)$ ,  $L(12)$ ,  $L(121)$ ,  $L(12112)$ ,  $L(121121)$ ,  $L(21)$ ,  $L(2112)$ , and  $L(21121)$ .

There are 6 positive roots (see Table A.2.1), and one can find in [KR11, Section 8.10] that the characters of the corresponding cuspidal modules are

$$1, \quad 2, \quad 12, \quad [2]_1 \cdot 112, \quad [3]_1! \cdot 1112, \quad \text{and} \quad [3]_1! \cdot 11212 + [3]_1![2]_2 \cdot 11122.$$

The first five clearly correspond to  $L(1)$ ,  $L(2)$ ,  $L(12)$ ,  $L(112)$ , and  $L(1112)$ . To get the last, we first compute using the quantum shuffle product

$$\text{ch}_q \text{Ind } L(112) \boxtimes L(12) = q^{-2}[3]_1! \cdot 11212 + q^{-2}[3]_1![2]_2 \cdot 11122 + q^{-1}[2]_1 \cdot 12112.$$

One can show that  $q^{-1}[2]_1 \cdot 12112$  corresponds to a submodule of  $\text{Ind } L(112) \boxtimes L(12)$  that is isomorphic to  $L(12112)\langle -1 \rangle$ . It follows that the last cuspidal is

$$(\text{Ind } L(112) \boxtimes L(12) / L(12112)\langle -1 \rangle) \langle 2 \rangle.$$

## 6.2 Affine type

### 6.2.1 Type $A_1^{(1)}$

We work with the Cartan datum coming from the generalized Cartan matrix

$$\begin{bmatrix} 2 & -2 \\ -2 & 2 \end{bmatrix}.$$

The simple monoweight modules fall in several infinite classes. For all  $m > 0$ , we know that  $L(1^m)$  and  $L(2^m)$  are simple monoweight modules. We also have

$$L(12), L(121), L(1212), L(12121), \dots,$$

$$L(21), L(212), L(2121), L(21212), \dots,$$

$$L(112), L(1122), L(11221), L(112211), \dots,$$

$$L(211), L(2112), L(21122), L(211221), \dots,$$

$$L(122), L(1221), L(12211), L(122112), \dots, \text{ and}$$

$$L(221), L(2211), L(22112), L(221122), \dots$$

Among these are many 1- and 2-jump modules. For example, from the first list, we see easily that  $L(121), L(12121), L(1212121), \dots$  are all 1-jump modules.

### 6.2.2 Type $A_1^{(2)}$

We work with the Cartan datum coming from the generalized Cartan matrix

$$\begin{bmatrix} 2 & -4 \\ -1 & 2 \end{bmatrix}.$$

For all  $m > 0$ , we know that  $L(1^m)$  and  $L(2^m)$  are simple monoweight modules. There are many other simple monoweight modules. In order to narrow the list a bit, we give infinite lists of 1-jump modules:

$$L(11112), L(1111221111), L(11112211112), L(1111221111221111), \dots,$$

$$L(11121), L(111212111), L(11121211121), L(111212111212111), \dots,$$

$$L(11211), L(11211211), L(11211211211), L(11211211211211), \dots,$$

$$L(12111), L(1211121), L(12111212111), L(1211121211121), \dots, \text{ and}$$

$$L(21111), L(211112), L(21111221111), L(211112211112), \dots$$

Note that  $L(12), L(121)$ , and  $L(21)$  are 2-jump modules.

### 6.3 Hyperbolic type

We work with the Cartan datum coming from the generalized Cartan matrix

$$\begin{bmatrix} 2 & -a \\ -b & 2 \end{bmatrix},$$

where  $a, b > 0$  and  $ab > 4$ . For all  $m > 0$ ,  $L(1^m)$  and  $L(2^m)$  are simple monoweight modules.

If  $a > 1$ , the 1-jump modules are:

$$L(1^{a2}), L(1^a22), L(1^a221^a), \dots$$

$$L(1^{a-1}21), L(1^{a-1}2121^{a-1}), L(1^{a-1}2121^{a-1}21), \dots$$

$$\vdots$$

$$L(21^a), L(21^a2), L(21^a221^a), L(21^a221^a2) \dots$$

We can list the 2-jump modules similarly.

# Appendices

# Appendix A

## Reference Tables

### A.1 Dynkin diagrams

In Table [A.1.1](#) we provide a list of Dynkin diagrams and a labeling of their nodes that is referenced throughout this dissertation.

### A.2 Positive roots

In Table [A.2.1](#) we provide an enumeration of the positive roots for a Lie algebra  $\mathfrak{g}$  corresponding to a Dynkin diagram in Table [A.1.1](#).



TABLE A.1.1: Dynkin diagram labeling as in [Lit98]



Type	Dynkin diagram	Longest word $w_0 = \mathbf{s}_1 \dots \mathbf{s}_n \in W$
$A_n$		$\mathbf{s}_k = s_k s_{k-1} \dots s_1$ for all $1 \leq k \leq n$
$B_n$		$\mathbf{s}_k = s_k s_{k-1} \dots s_2 s_1 s_2 \dots s_k$ for all $1 \leq k \leq n$
$C_n$		same as for $B_n$
$D_n$		$\mathbf{s}_1 = s_1, \mathbf{s}_2 = s_2,$ $\mathbf{s}_k = s_k s_{k-1} \dots s_3 s_1 s_2 \dots s_k$ for all $3 \leq k \leq n$
$E_6$		same as $D_5$ except $\mathbf{s}_6 = s_6 s_2 s_3 s_1 s_4 s_5 s_3 s_4 s_2 s_3 s_1 s_6 s_2 s_3 s_4 s_5$
$E_7$		same as $E_6$ except $\mathbf{s}_7 = s_7 s_6 s_2 s_3 s_1 s_4 s_5 s_3 s_4 s_2 s_3 s_1 s_6 s_2 s_3 s_4$ $s_5 s_7 s_6 s_2 s_3 s_1 s_4 s_3 s_2 s_6 s_7$
$E_8$		same as $E_7$ except $\mathbf{s}_8 = s_8 s_7 s_6 s_2 s_3 s_1 s_4 s_5 s_3 s_4 s_2 s_3 s_1 s_6 s_2 s_3$ $s_4 s_5 s_7 s_6 s_2 s_3 s_1 s_4 s_3 s_2 s_6 s_7 s_8 s_7 s_6 s_2 s_3$ $s_1 s_4 s_5 s_3 s_4 s_2 s_3 s_1 s_6 s_2 s_3 s_4 s_5 s_7 s_6 s_2 s_3$ $s_1 s_4 s_3 s_2 s_6 s_7 s_8$
$F_4$		same as $B_3$ except $\mathbf{s}_4 = s_4 s_1 s_2 s_3 s_1 s_2 s_1 s_4 s_1 s_2 s_3 s_1 s_2 s_1 s_4$
$G_2$		$\mathbf{s}_1 = s_1, \mathbf{s}_2 = s_2 s_1 s_2 s_1 s_2$

TABLE A.2.1: Enumerations of positive roots

Type	Positive roots
$A_n$	$\alpha_{i,j} := \alpha_i + \alpha_{i+1} + \cdots + \alpha_j \quad 1 \leq i \leq j \leq n$
$B_n$	$\alpha_{i,j} := \alpha_i + \alpha_{i+1} + \cdots + \alpha_j \quad 1 \leq i \leq j \leq n$ $\beta_{i,j} := 2\alpha_1 + \cdots + 2\alpha_i + \alpha_{i+1} + \cdots + \alpha_j \quad 1 \leq i < j \leq n$
$C_n$	$\alpha_{i,j} := \alpha_i + \alpha_{i+1} + \cdots + \alpha_j \quad 1 \leq i \leq j \leq n$ $\beta_{i,j} := \alpha_1 + 2\alpha_2 \cdots + 2\alpha_i + \alpha_{i+1} + \cdots + \alpha_j \quad 2 \leq i \leq j \leq n$
$D_n$	$\alpha_{i,j} := \alpha_i + \alpha_{i+1} + \cdots + \alpha_j \quad 2 \leq i \leq j \leq n$ $\beta_i := \alpha_1 + \alpha_3 + \alpha_4 \cdots + \alpha_i \quad 2 \leq i \leq n$ $\gamma_{i,j} := \alpha_1 + \alpha_2 + 2\alpha_3 + \cdots + 2\alpha_i + \alpha_{i+1} + \cdots + \alpha_j \quad 2 \leq i < j \leq n$
$G_2$	$\alpha_1, \alpha_2, \alpha_1 + \alpha_2, 2\alpha_1 + \alpha_2, 3\alpha_1 + \alpha_2, 3\alpha_1 + 2\alpha_2$

# Appendix B

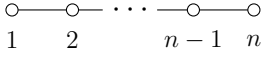
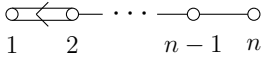
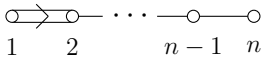
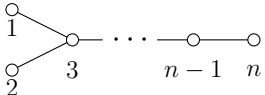
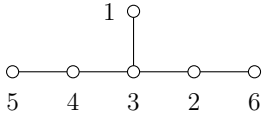
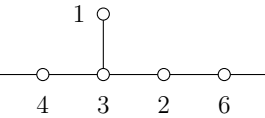
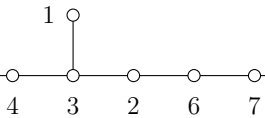
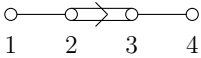
## Basis Reduction

### B.1 Reducing to a sum over a chosen basis

We work over an arbitrary Cartan datum (see Section 2.1). Let  $\alpha \in Q^+$  and let  $R(\alpha)$  be the corresponding KLR algebra.

Here we describe an algorithm for writing any single term consisting of a product of generators of  $R(\alpha)$  as a linear combination of elements of the basis described in Theorem 3.1.4. It will suffice to assume that the term lies in  $R(\alpha)e(\mathbf{i})$  for some  $\mathbf{i} \in I^\alpha$ . If this is not the case, we can multiply on the right by  $1 = \sum_{\mathbf{j} \in I^\alpha} e(\mathbf{j})$  to get a sum of terms of this form, then perform the algorithm on each term separately.

We shall assume that we have a procedure which can take in a product of symmetric generators and output a list of relations to apply in order to reduce the product to some prescribed minimal-length form.

The execution of the recursive method `TermReduce` can be visualized as an oriented tree in which the root is given by the input term  $x$ , the arrows indicate the application of a

KLR relation, and the leaves represent (multiples of) basis vectors. The leaves can be added together to form a basis representation of  $x$ . The leaves of the tree are contained in the list  $y$ , and  $w$  is the basis representation of  $x$  obtained by summing all items in  $y$ .

---

**Algorithm 1** Reduction to sum over basis of Theorem 3.1.4

---

```

1:  $x \leftarrow$  a term in  $R(\alpha)e(\mathbf{i})$ 
2:  $y \leftarrow$  empty list
3: TermReduce( $x$ )
4:  $w \leftarrow$  sum of items in  $y$ 
5:
6: procedure TERMREDUCE( $x$ )
7:   if  $x$  is a multiple of a basis element then
8:     add  $x$  to  $y$ 
9:   return
10:  if  $x$  contains a pair of adjacent unequal idempotents then return
11:  if an idempotent in  $x$  is out of position then
12:    apply (3.1.3) or (3.1.4) to  $x$  to move the idempotent to the right
13:    TermReduce( $x$ )
14:  return
15:  if a polynomial generator in  $x$  is out of position then
16:    apply (3.1.5), (3.1.7a), or (3.1.7b) to  $x$  to move polynomial generator right
17:    run TermReduce on each summand of  $x$ 
18:  return
19:   $rel \leftarrow$  a list of symmetric group relations to apply in order to reduce the product of
    symmetric generators at the beginning of  $x$  to its prescribed minimal-length form
20:  for  $r$  in  $rel$  do
21:    apply relation (3.1.6), (3.1.8a), (3.1.8b), (3.1.8c), (3.1.9a), or (3.1.9b) correspond-
    ing to  $r$  to  $x$ 
22:    run TermReduce on each new summand of  $x$ 
23:  add  $x$  to  $y$ 

```

---

# Bibliography

- [BKOP14] Georgia Benkart, Seok-Jin Kang, Se-jin Oh, and Euiyong Park, *Construction of irreducible representations over Khovanov-Lauda-Rouquier algebras of finite classical type*, Int. Math. Res. Not. IMRN **5** (2014), 1312–1366. MR3178600
- [FL15] Gabriel Feinberg and Kyu-Hwan Lee, *Fully commutative elements of type  $D$  and homogeneous representations of KLR-algebras*, J. Comb. **6** (2015), no. 4, 535–557. MR3382608
- [GL93] I. Grojnowski and G. Lusztig, *A comparison of bases of quantized enveloping algebras*, Linear algebraic groups and their representations (Los Angeles, CA, 1992), 1993, pp. 11–19. MR1247495
- [HK02] J. Hong and S.-J. Kang, *Introduction to quantum groups and crystal bases*, Graduate Studies in Mathematics, vol. 42, American Mathematical Society, Providence, RI, 2002.
- [HL10] Alexander E. Hoffnung and Aaron D. Lauda, *Nilpotency in type  $A$  cyclotomic quotients*, J. Algebraic Combin. **32** (2010), no. 4, 533–555. MR2728758 (2011m:20009)
- [HMM12] David Hill, George Melvin, and Damien Mondragon, *Representations of quiver Hecke algebras via Lyndon bases*, J. Pure Appl. Algebra **216** (2012), no. 5, 1052–1079. MR2875327
- [Kac90] Victor G. Kac, *Infinite dimensional Lie algebras*, 3rd ed., Cambridge University Press, 1990.
- [Kas91] Masaki Kashiwara, *On crystal bases of the  $q$ -analogue of universal enveloping algebras*, Duke Math. J. **63** (1991), no. 2, 465–516.
- [KK12] Seok-Jin Kang and Masaki Kashiwara, *Categorification of highest weight modules via Khovanov-Lauda-Rouquier algebras*, Invent. Math. **190** (2012), no. 3, 699–742. MR2995184

- [KL09] Mikhail Khovanov and Aaron D. Lauda, *A diagrammatic approach to categorification of quantum groups I*, Represent. Theory **13** (2009), 309–347. MR2525917 (2010i:17023)
- [KL11] ———, *A diagrammatic approach to categorification of quantum groups II*, Trans. Amer. Math. Soc. **363** (2011), no. 5, 2685–2700. MR2763732 (2012a:17021)
- [Kle14] Alexander S. Kleshchev, *Cuspidal systems for affine Khovanov-Lauda-Rouquier algebras*, Math. Z. **276** (2014), no. 3-4, 691–726. MR3175157
- [KR10] Alexander Kleshchev and Arun Ram, *Homogeneous representations of Khovanov-Lauda algebras*, J. Eur. Math. Soc. (JEMS) **12** (2010), no. 5, 1293–1306. MR2677617 (2011m:20010)
- [KR11] ———, *Representations of Khovanov-Lauda-Rouquier algebras and combinatorics of Lyndon words*, Math. Ann. **349** (2011), no. 4, 943–975. MR2777040 (2012b:16078)
- [Lec04] Bernard Leclerc, *Dual canonical bases, quantum shuffles and  $q$ -characters*, Math. Z. **246** (2004), no. 4, 691–732. MR2045836 (2005c:17019)
- [Lit98] Peter Littelmann, *Cones, crystals, and patterns*, Transform. Groups **3** (1998), no. 2, 145–179. MR1628449 (99e:17009)
- [LR95] Pierre Lalonde and Arun Ram, *Standard Lyndon bases of Lie algebras and enveloping algebras*, Trans. Amer. Math. Soc. **347** (1995), no. 5, 1821–1830.
- [Lus10] George Lusztig, *Introduction to quantum groups*, Modern Birkhäuser Classics, Birkhäuser/Springer, New York, 2010. Reprint of the 1994 edition. MR2759715
- [Lus90] G. Lusztig, *Canonical bases arising from quantized enveloping algebras*, J. Amer. Math. Soc. **3** (1990), no. 2, 447–498. MR1035415
- [LV11] Aaron D. Lauda and Monica Vazirani, *Crystals from categorified quantum groups*, Adv. Math. **228** (2011), no. 2, 803–861. MR2822211 (2012i:17013)
- [McN14] Peter J. McNamara, *Representations of Khovanov–Lauda–Rouquier algebras III: Symmetric Affine Type* (2014). [arxiv:1407.7304v2](https://arxiv.org/abs/1407.7304v2).
- [McN15] ———, *Finite dimensional representations of Khovanov–Lauda–Rouquier algebras I: Finite type*, J. Reine Angew. Math. **707** (2015), 103–124. MR3403455

- [NZ97] Toshiki Nakashima and Andrei Zelevinsky, *Polyhedral realizations of crystal bases for quantized Kac–Moody algebras*, Adv. Math. **131** (1997), no. 1, 253–278. MR1475048 (98m:17023)
- [Rou08] Raphaël Rouquier, *2–Kac–Moody algebras* (2008). arXiv:0812.5023.
- [TW13] Peter Tingley and Ben Webster, *Mirkovic–Vilonen polytopes and Khovanov–Lauda–Rouquier algebras* (2013). arXiv:1210.6921.
- [Web13] Ben Webster, *Knot invariants and higher representation theory* (2013). arXiv:1309.3796.